

Troop 1292 # 62

MERIT BADGE SERIES

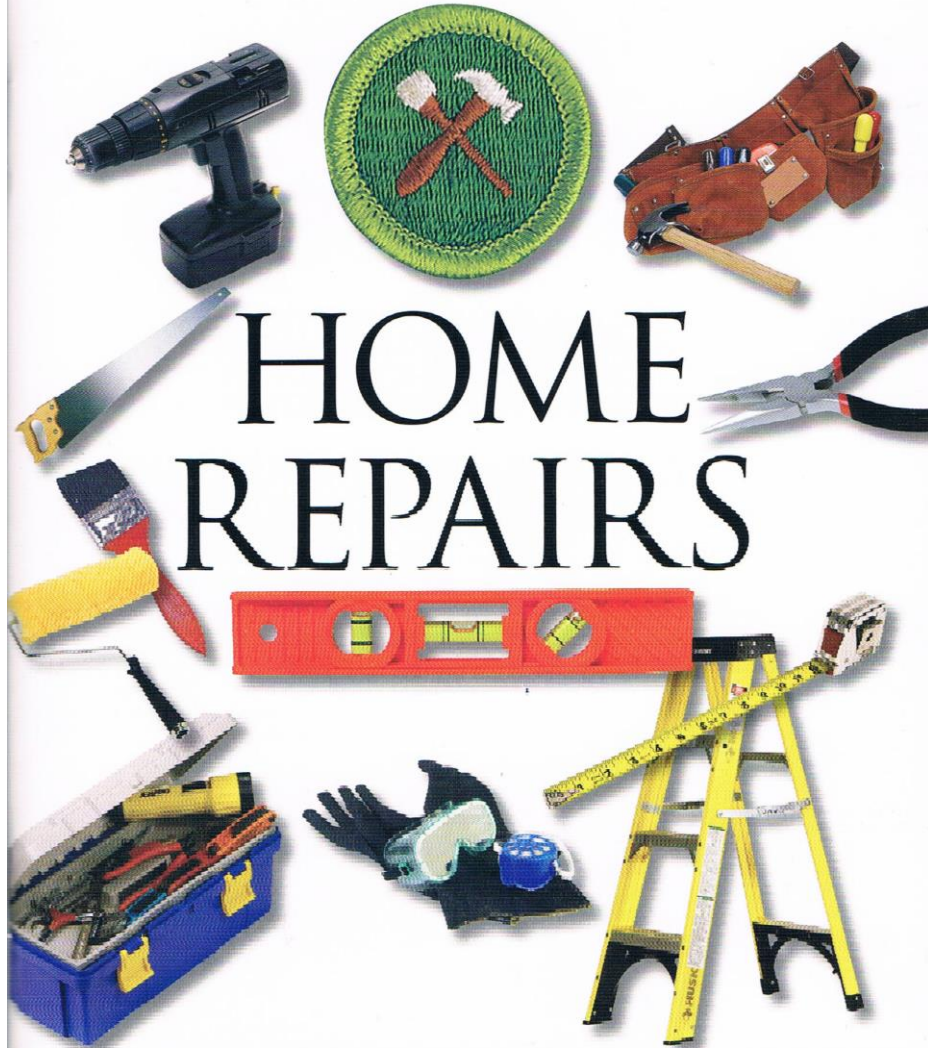

HOME REPAIRS



BOY SCOUTS OF AMERICA®

HOME REPAIRS



"Enhancing our youths' competitive edge through merit badges"



HOW TO USE THIS PAMPHLET

The secret to successfully earning a merit badge is for you to use both the pamphlet and the suggestions of your counselor.

Your counselor can be as important to you as a coach is to an athlete. Use all of the resources your counselor can make available to you.

This may be the best chance you will have to learn about this particular subject. Make it count.

If you or your counselor feels that any information in this pamphlet is incorrect, please let us know. Please state your source of information.

Merit badge pamphlets are reprinted annually and requirements updated regularly. Your suggestions for improvement are welcome.

Send comments along with a brief statement about yourself to National Advancement Committee, 5209 • Boy Scouts of America • 1325 West Walnut Hill Lane • P.O. Box 152079 • Irving, TX 75015-2079 • merit_badge@Scouting.org.

WHO PAYS FOR THIS PAMPHLET?

This merit badge pamphlet is one in a series of more than 100 covering all kinds of hobby and career subjects. It is made available for you to buy as a service of the national and local councils, Boy Scouts of America. The costs of the development, writing, and editing of the merit badge pamphlets are paid for by the Boy Scouts of America in order to bring you the best book at a reasonable price.



Note to the Counselor

Nothing encourages pride in one's surroundings more than being able to improve them through one's own initiative and resources.

That is why the Home Repairs merit badge can be so important to the development of a young person. Once a Scout learns basic home repair skills and applies them to his own environment, he will have a lifetime resource: his ability to learn new skills.

Home repair, however, can be intimidating at first, especially if the Scout lacks a role model for such activities. If possible, provide one-on-one or group activities that will get the Scout off to a good start.

Encourage each Scout to acquire a good set of basic tools, and help Scouts learn to keep their tools in one place and in good repair. That way, they will "be prepared" to handle repairs as needed.

There is no time limit for completing the requirements. Major tasks, such as waterproofing a basement, may be completed in tandem with another Boy Scout working on the requirement, and/or with the assistance of an adult. The majority of the work, however, should be performed by the Scouts earning the badge.

This book provides a good overview of home-repair projects, but it is by no means a complete reference. For some requirements, space does not permit going into construction details or listing all possible repair variations. Therefore, any new construction or installation or completion of a similar project (for example, any toilet repair or adjustment) qualifies as achieving the requirement so long as the Boy Scout understands and demonstrates the basic concepts involved.



Requirements

1. Do the following:
 - a. Explain to your counselor the most likely hazards you may encounter while working on home repairs and what you should do to anticipate, mitigate and prevent, and respond to these hazards. Describe the appropriate safety gear and clothing that should be used when working on home repairs.
 - b. Discuss general precautions related to home repairs. Name at least 10 safe practices that every home repairer should exercise.
2. Under the supervision of your merit badge counselor, do FOUR of the following:
 - a. Maintain or recondition a yard tool and show that you know how to clean up and properly store this equipment.
 - b. Weather-strip a window or door.
 - c. Caulk cracks or joints open to the weather.
 - d. Waterproof a basement.
 - e. Repair a break in a concrete or asphalt surface.
 - f. Repair the screen in a window or door.
 - g. Replace a pane of glass.
 - h. Solder a broken wire or metal object.
3. Under the supervision of your merit badge counselor, do THREE of the following:
 - a. Install or build equipment for storing tools.
 - b. Build a workbench.

Either a parent or the merit badge counselor may supervise the Scout's work on any Home Repairs requirements.

- c. Repair a piece of furniture.
 - d. Paint or varnish a piece of furniture, a door, or trim on a house.
 - e. Repair a sagging door or gate.
 - f. Repair a loose step or railing.
 - g. Repair a fence.
4. Under the supervision of your merit badge counselor, do TWO of the following:
- a. Locate a main electrical switch box and know how to replace a fuse or reset a circuit breaker.
 - b. Replace an electrical cord or repair a plug or lamp socket.
 - c. Install a single-pole light switch.
 - d. Replace an electrical wall outlet.
5. Under the supervision of your merit badge counselor, do TWO of the following:
- a. Clear a clogged drain or trap.
 - b. Repair a leaky water faucet.
 - c. Repair a flush toilet.
 - d. Repair a leaky hose or connector.
 - e. Clean or replace a sprinkler head.
6. Under the supervision of your merit badge counselor, do THREE of the following:
- a. Paint a wall or ceiling.
 - b. Repair or replace damaged tile, linoleum, or vinyl flooring.
 - c. Install drapery or curtain rods and then hang drapes or curtains.
 - d. Replace window blind cords.
 - e. Repair or replace a window sash cord.
 - f. Reinforce a picture frame.
 - g. Mend an object made of china, glass, or pottery.

Contents

Be Prepared for Home Repairs	7
Electrifying Projects	21
Water Works	29
Wall Works, Caulking, and Weather-Stripping	39
Flooring Fix-Ups	50
All About Windows	59
Home Furnishings How-Tos	67
Doors and More	74
Home Repairs Resources	78



When climbing, face the ladder and use both hands—don't carry anything in your hands. Don't overreach when you are on a ladder, as it may tip and fall. Never stand on the top two rungs of a ladder.

- Never drop tools or other objects from a height—lower them with a rope.
- Always wear safety glasses when working with dust, heat, flying objects, or power tools.
- Wear a disposable mask when working with odorous materials, dusts, or mists. Use a special respirator when working with toxic substances.
- Store containers of flammable and volatile liquids, such as paint thinner and gasoline, carefully. Keep the containers tightly closed and away from heat or flames. Don't use power tools near flammable or volatile liquids; sparks from the tools could ignite the vapors, even at a distance.
- Make sure to have working smoke detectors and fully charged fire extinguishers in the garage and workshop, as well as in the kitchen. They should be listed with Underwriters Laboratories, a safety testing and certification organization.

Asbestos Hazards

Asbestos is a mineral fiber that has been used for many years in some building construction materials for insulation and as a fire-retardant. It is most commonly found in older homes, in pipe and furnace insulation materials, asbestos shingles, millboard, textured paints and other coating materials, and floor tiles. Many remodeling activities can release airborne asbestos fibers, which can cause serious lung and breathing diseases. Therefore, when planning a project that involves any of these materials, you should have them checked to see whether they may contain asbestos. If they do, have the work done by someone who is specially trained to work with asbestos. Contact the Environmental Protection Agency for more information (see the resources section in this pamphlet).

Working With Tools

- Avoid working with power tools when you are tired or taking any medication.
- Always read the tool manufacturer's instructions, especially warnings, before using a tool.
- Never carry sharp objects in your pockets; put them in a utility belt with secure pockets and holders.
- Make sure your power tools are in good condition, and don't disable safety guards on power tools. When possible, plug power tools into outlets protected with ground fault circuit interrupters (GFCIs).
- Always work away from your body; that is, never point a sharp object, such as a screwdriver or a chisel, toward you as you are working.
- Never support a work piece with your leg or other body part when sawing or using a power tool.
- Keep your hands and fingers away from the business end of blades, cutters, and bits.
- It's best to cut small pieces of wood or pipe off of a larger piece. If you must work with small pieces, clamp them to a steady work surface when sawing or drilling; use a holder or pusher when working on a table saw or miter.
- Always remove the key from a drill chuck before starting the drill.



Safety First

Appropriate safety gear is as important as good tools!

The responsible home repairer should always wear appropriate safety gear—including safety glasses, masks, heavy gloves, and even ear protection—when needed.

A Few Good Tools: Basic Equipment for Home Repairs

The home repair beginner needs only a few basic tools, but they should be of good quality. Well-made and well-maintained tools can serve you a lifetime, whereas cheap tools often make work more difficult and need to be replaced more often.



Be Prepared for Home Repairs

There is no better way to be prepared for everyday living than earning the Home Repairs merit badge. Successfully completing this badge's requirements can lead to a lifetime of personal and financial rewards.

Doing basic home repairs will give you a sense of personal pride in your achievements and increased self-confidence. In addition, safe and successful do-it-yourselfers can easily save a family thousands of dollars in repair bills over the years.

Safety First: General Precautions

Throughout this book, you will find safety tips specific to the task being described, but here are some general precautions that every home repairer should keep in mind. Strive to incorporate safe practices into every project. In time, safety will become second nature to you.

General Working Tips

- Always have enough lighting for the project.
- Keep long hair pulled back and avoid wearing jewelry or loose clothing when working with power tools or machinery with moving parts.
- Keep your work area clean and free of clutter.
- Choose the right ladder for the project (step ladder or extension ladder? how long? metal, fiberglass, or wood? etc.). Lean the top of the ladder against something solid and place the ladder at the proper angle (one foot away from the wall for every four feet of working ladder height) with the base on firm, level ground.



Your first concern during any repair or maintenance project should be safety.

In the long run, endangering your health or safety, or that of your family, is much more costly than paying a qualified person to do the work.



Tools

These suggested tools and supplies will get you started on most home repairs.

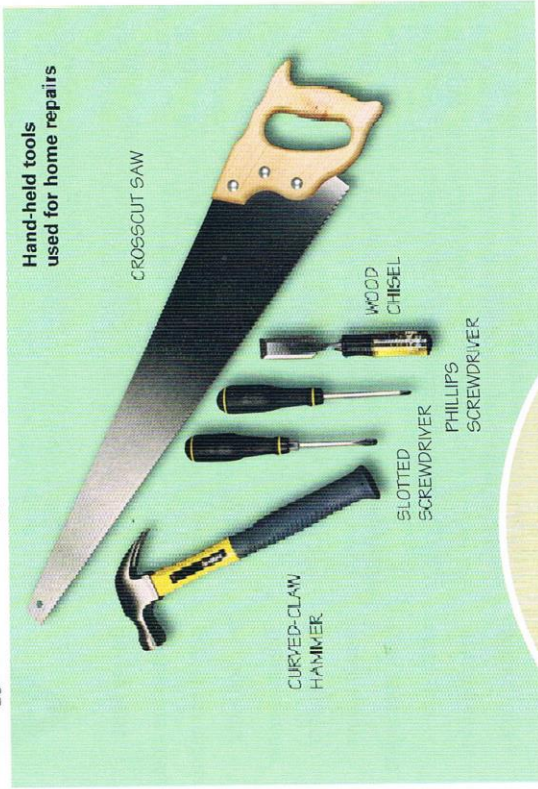

Handy helpers for many types of repairs

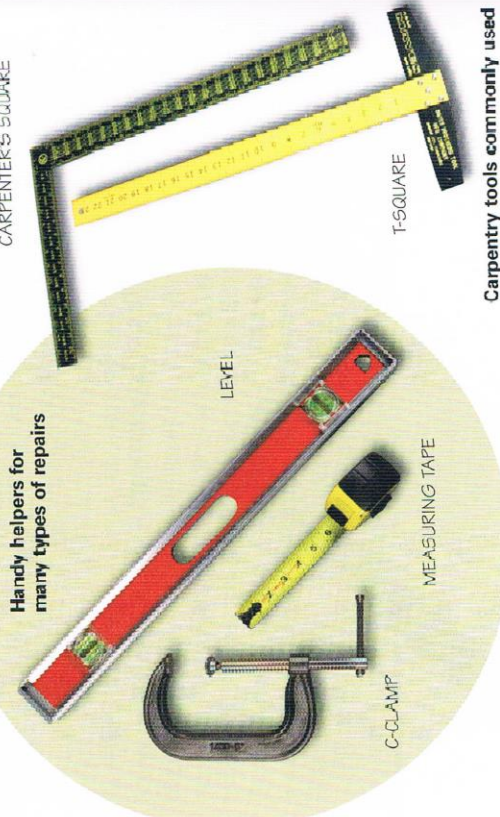

Carpentry tools commonly used in minor home repairs



Hand and power tools used for carpentry, electric work, and other repairs



Household tools handy for minor repair projects

Supplies

- Flashlight
- Can of lubricating oil
- Assorted nails, screws, bolts, and washers
- Sandpaper in assorted grits, or textures
- Steel wool in assorted grades
- Electrical tape and masking tape
- All-purpose white glue and wood glue (Buy special glues for specific tasks.)

Nail Types



Common. The old standby for general construction work.



Box. Looks a lot like the common nail but has a narrower shank. Used with thin wood so the wood doesn't split.



Finishing. For finished construction work. The head can be driven flush with the work, or countersunk (driven below the surface) and completely hidden with filler.



Casing. Also for finished construction work, with a head that lends itself to countersinking and a finished look.



Roofing. The broad head will not pull through shingles, keeping them from tearing loose.



Concrete. For fastening in masonry. Should be set in one blow with a heavy (64-ounce) hammer.

Nail Sizes

PENNY SIZE

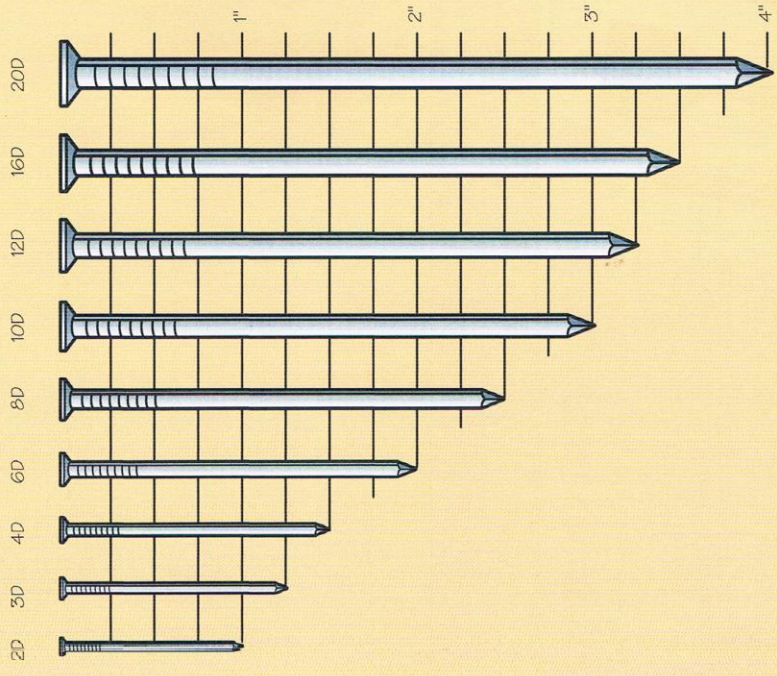

The lengths of common nails are expressed in "penny" ratings—a number followed by the letter "d," which is the symbol for "pence" in the old monetary system in England, where this rating system began. Nails used to be sold by the number of pence (pennies) you needed to buy 100 nails; therefore, you needed six pence to buy 100 6d nails.

Wood Screws

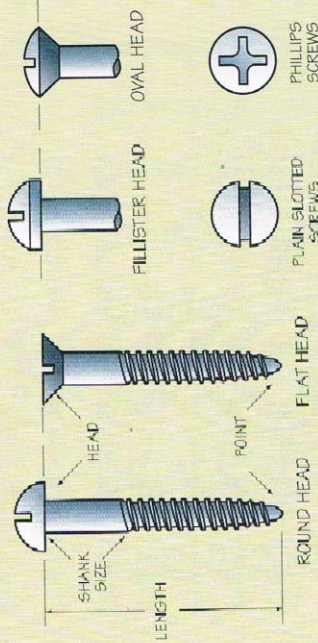

WASHERS AND NUTS

- **Flat washer.** Protects the surface.
- **Toothed washer (internal).** A lock washer that yields a finished look because the teeth are hidden by the bolt head or nut.
- **Spring lock/split washer.** The most common lock washer, used to prevent loosening by vibration.
- **Square nut.** Four-sided general-purpose nut.
- **Flat square nut.** Four-sided nut, smaller than a square nut.
- **Wing nut.** Hand-tightened with the fingers instead of a wrench. Ideal to use when something needs to be removed frequently.
- **Hexagonal nut.** Six-sided general-purpose nut that is sturdier than a square nut.
- **Acorn nut/cap nut.** Protects threads from the elements.

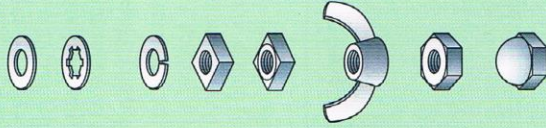

Storing Tools and Equipment

Storing your tools in a safe, secure place is the best way to take care of them. Hardware stores sell an assortment of prefabricated toolboxes, hangers, and pegboard that you can use to store your tools and equipment. If you return your tools to their proper place as soon as you are finished with a project, you will always know where to find them again.

If your family does not have a workbench or a place to store tools, a good way to begin this merit badge is by making one or both.

Prevention goes hand in hand with mitigation, which means "to lessen in force or intensity" and "to make less severe." By taking precautions to manage risk and the possibility of injury, you can be prepared to anticipate, help prevent, mitigate, and respond to just about any incident that might happen while working on home repairs.

Maintaining Yard Tools

As with all tools, yard tools that are sharp and well-maintained will make your work easier and safer. Avoid rust by cleaning excess dirt from tools with a wire brush, then spraying tools with a spray lubricant or wiping them with an oily rag after each use.

When sharpening tools with a whetstone or file, hold the stone or file at an angle and move away from the cutting edge. Be sure to maintain the factory-set bevel (the slant of the edge). It's best to have a professional sharpen saws and other cutting tools with serrated edges.

Always replace broken or split handles on tools. You can get replacement handles at a hardware store. To remove the old handle, file off the head of the rivet that holds the handle in place. Secure the new handle with the appropriate type of glue and let it dry completely before using the tool again.

DRILL BITS

1. **Twist bit.** All-purpose bit.
2. **Spade bit.** For drilling large holes in wood.
3. **Masonry bit.** For boring into brick, concrete, or plaster at low speeds.

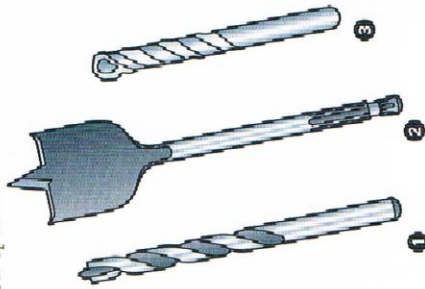

Toolbox

You can make a simple toolbox with some basic materials and equipment. Use a pencil to mark the dimensions for all the pieces on the plywood, and cut out the pieces with a crosscut saw. Make the holes for the dowel using a spade bit on an electric drill. Be sure that the bit is the same dimension as the diameter of the dowel.

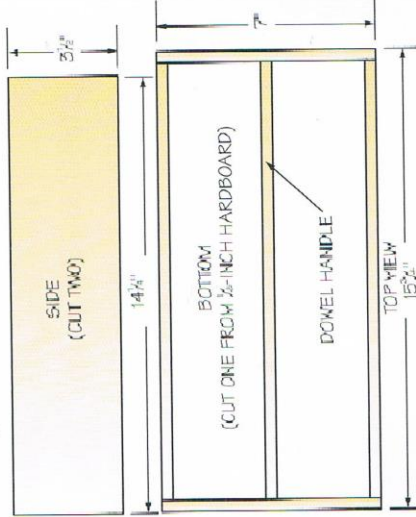
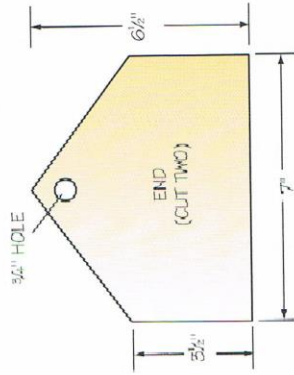
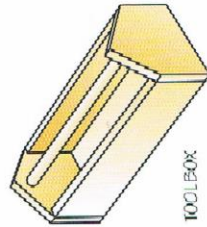

Glue and nail the side pieces to the hardwood bottom. Nail an end piece to the base and sides. Use wood glue to set the dowel in place. Then nail the other end piece in place, using glue again as you set the dowel.

For extra strength, use wood screws instead of nails in this assembly, predrilling holes and then countersinking the screws.

Pegboard Storage With Work Surface

This project gives you an area for doing light work as well as a place to hang your tools. Start with a pegboard and plywood board of the same size. Make a frame of 1-by-4-inch or 2-by-4-inch boards in the same dimension as the pegboard and plywood board.

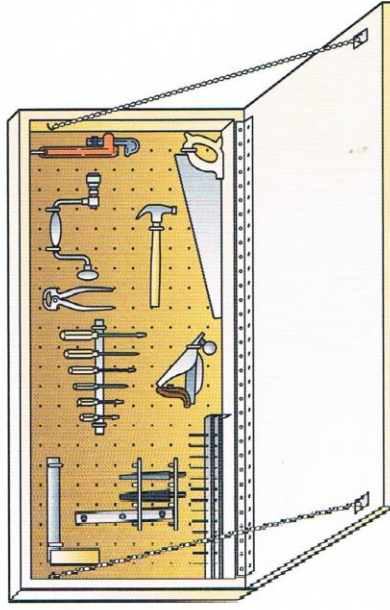

Nail or screw the pegboard to the back of the frame. Attach the plywood work surface to the frame with a piano hinge. Drill holes for chain hooks and secure the hooks with nuts. Add a lightweight link chain for additional support. Use a screen hook-and-eye or hinge clasp to close the case when you are not using it. Secure the box onto wall studs or a staircase with wood screws.

Materials

- Top (two): 24 x 60 x 3/4-inch plywood
- Shelf (one): 19 1/2 x 48 x 3/4-inch plywood
- Top side braces (two): 2 x 4 x 21-inch lumber
- Top front and back braces (two): 2 x 4 x 45-inch lumber
- Bottom side braces (two): 2 x 4 x 18-inch lumber
- Bottom front and back braces (two): 2 x 4 x 45-inch lumber
- Sides (two): 21 x 27 x 1/4-inch plywood
- Back (one): 27 x 48 x 1/4-inch plywood
- No. 14 x 3-inch flat-head wood screws
- 6d nails
- White glue
- Wood putty (optional)

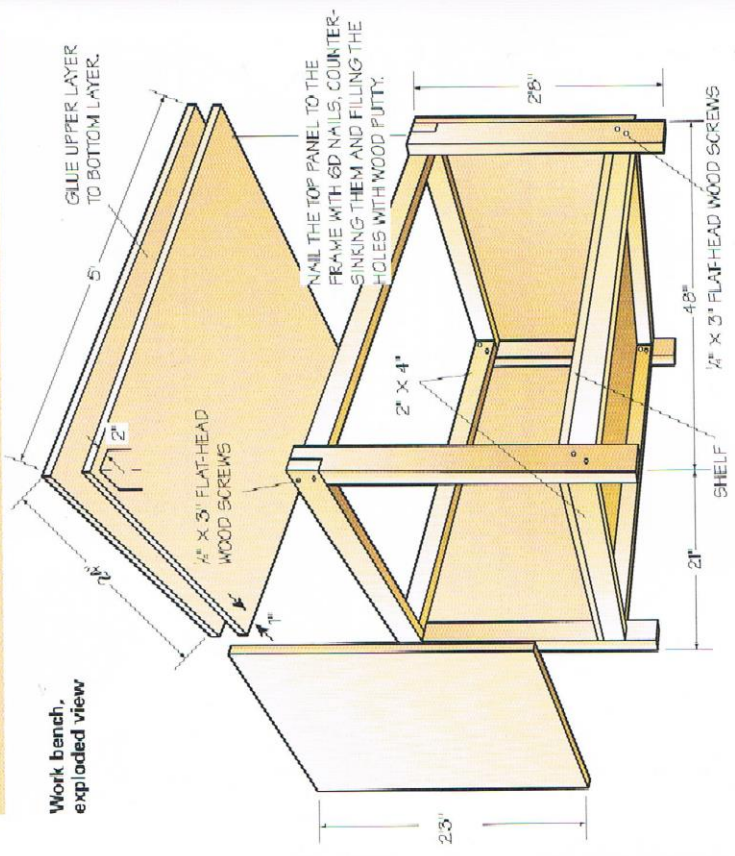

Work bench, exploded view

Workbench

Make a handy temporary bench for heavy work by placing a 2-inch-thick plywood board over two sawhorses. Nail the board to the sawhorses for stability. For a more permanent bench with a storage shelf, make the one shown here. If you use it against a wall, allow 2 feet of clearance at both ends for large work. If you use it in the center of the shop, supply electricity from above so that you won't trip on extension cords as you work.

Preparing the Pieces

- Step 1**—Mark a 4-by-8-inch sheet of 1/4-inch plywood according to the panel diagram shown. Mark the side and back dimensions on 1/4-inch plywood.
- Step 2**—Cut out the top and shelf pieces with a handsaw or circular saw. Notch the corners of the shelf. Cut the side and back pieces.
- Step 3**—Cut the legs and braces according to the dimensions shown. In one end of each of the four legs, cut a notch 3/2 inches deep and 1 1/2 inches in. Pre-drill screw holes for the top side braces (you will countersink the screws).

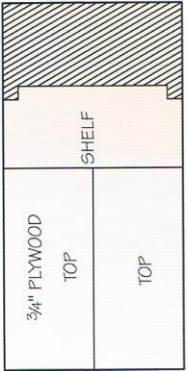

Panel diagram

Assembling the Frame

- Step 1**—Screw the top side braces to the legs.
- Step 2**—Fasten the bottom side braces to the legs with glue, and then screw the braces to the legs.
- Step 3**—Glue and nail one side panel to one leg assembly.
- Step 4**—Glue and screw the front and back braces to the legs at the top and bottom.

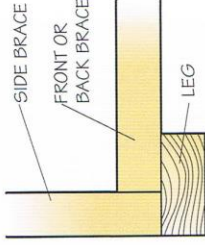

Bottom brace corner

Completing the Bench

- Step 1**—Install the lower shelf in the frame through the open end. Glue and nail it in place.
- Step 2**—Center the smaller of the two top panels on the frame. Glue and nail them in place.
- Step 3**—Glue and nail the back panel and remaining side panel in place.
- Step 4**—Center the larger top panel on the bench. Glue it, weight it down, and allow it to dry overnight.

Electrifying Projects

Safety First

Electricity is dangerous. Respect it by following these simple rules.



Turn Off the Juice

- Always shut off or disconnect power at the main service panel (fuse or circuit breaker box) before handling wires; working on a switch, plug, or outlet; or opening a junction box.
- Always unplug an electric object or power tool before working on it.
- Never work on a live circuit. Use a meter or tester to check that the circuit you are working on is not live.
- Don't trust labels on circuits; the circuits may have been changed, but the labels may not reflect those changes.
- Never work in the dark; use a flashlight whenever necessary.

Keep It Dry

- Never stand on a damp or wet floor when working at the fuse or circuit breaker box, or when using power tools. Stand on a rubber mat or a piece of dry wood. Never work with electricity when you are wet; be safe and change into dry clothes.
- Never touch any plumbing when working in or around a fuse or circuit breaker box. Wear rubber-soled shoes.

Leave Conducting for Trains

- When replacing fuses, work with one hand, keeping the other behind your back or in your pocket to prevent electricity from making a complete circuit through your chest.





Underwriters

Laboratories

Inc. (UL) is an independent, not-for-profit product

safety testing and certification organization.

A UL label or stamp (above)

means that the product meets nationally

recognized safety standards. Look for this label

when purchasing any electrical products.

- Lines coming into service panels remain live even when a main breaker is turned off or main fuses are removed. Never open a service panel. Consult a qualified electrician if you suspect a problem with the service panel.

- Unusually warm or hot switches or receptacles may indicate an unsafe wiring condition. Unplug cords from such receptacles and do not use the switches. Have an electrician check the wiring as soon as possible.

- Never use a metal ladder when working with electricity. Metal conducts electricity; if you touch metal while also touching a live wire, electrical current will flow through your body.

Watch Your Cords

- Never substitute an extension cord for permanent wiring.
- Never use damaged cords, and be careful not to fold or crimp cords too tightly. Unplug extension cords when you are finished using them.
- Never plug two extension cords together; use one cord that is the correct length. Make sure the extension cord you use matches the cord of the tool (for example, three-prong grounded or double-insulated).
- Never run extension cords through doorways or windows, or under carpets. Never fasten them to walls or baseboards; even though staples are sold for this purpose, it is not a safe practice.

Think Safety

- Never push yourself when working on any electrical project. Make sure you give yourself the time to think the project through completely; mistakes can happen when you rush projects.
- Above all, use good judgment when planning your project; if you don't feel comfortable, leave the job to a qualified electrician and insist that he or she follow appropriate electrical codes.

Good Working Practices

In addition to following the safety rules, it is a good idea to use good working practices. When working with electrical wires, label them as you work to keep track of them. Number them and write down where they are attached and to what. Also, fold wires neatly back into the box when repairing or replacing switches and receptacles. Running electrical tape around the switch under the mounting screws will protect the wire connections.

Always use the proper tools, with *insulated* handles, for the job. For example, use wire strippers or wire cutters (diagonal pliers) to strip wire and avoid damaging wires. A multipurpose electrical tool both cuts wires and strips the insulation from them. Wire gauges printed on the tool show which hole to use so that you don't damage the wire.

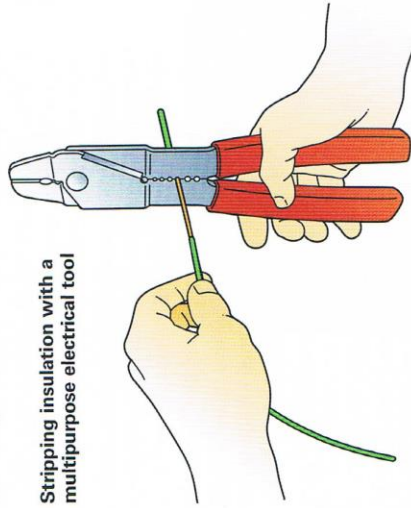

Stripping insulation with a multipurpose electrical tool

The Basics of Electricity

The most common electrical service to homes in the United States is 240 volts. The *amperage*, or strength of the electric current, in any home can vary.

Modern homes may have 200 amps or more, whereas older city homes may have as little as 60 amps or even less. Your main breaker or fuses will indicate how many amps are in your home.

Electrical *current*, or the rate of flow of electricity, is measured in *amperes*; the pressure that forces the current through a conductor is measured in *volts*; and the power of the electrical current is measured in *watts*.

Toggles in a circuit breaker flip to "off" or to a center position for both short circuits and circuit overloads. To reset the circuit and restore power, flip the switch to full "off" and then back to "on."

Circuit breaker fuses have a reset button or switch. When blown, they can be reactivated with the button or switch. Push the switch to the "off" position, then back to the "on" position.

The main electrical service entrance to your home is through a *service panel* containing fuses, circuit breakers, or both. The panel usually is located in the basement or utility room, or in a closet on an outside wall. An older home can have more than one service entrance, and many homes have additional disconnect panels for outside supplies, such as air-conditioner compressors.

Replacing a Fuse

Fuses are rated by amperes, or *amps*. Never replace a fuse with one that has the improper amperage rating or size. A switch box could have several different types of fuses, all of which can be replaced by simply removing the defective fuse and putting a new one in its place. Unscrew the blown fuse by touching only the glass end. Then screw in the replacement, touching the glass end only.

- *Plug fuses* (15 to 30 amps) look like flattened screw-in light bulbs and have a metal filament under a small glass window. If the window is blackened or discolored, the fuse may be defective.
- *Cartridge fuses* are cylindrical. Cap-ended cartridge fuses are rated up to 60 amps and are for circuits with high-current appliances such as stoves, dryers, and ovens. Prong-ended cartridge fuses protect main electrical services and are rated up to 600 amps. It is rare, but possible, for them to fail.
- *Dual-element, time-delay fuses* have a springlike mechanism that allows for brief electrical surge overloads without the fuse blowing. They are useful on circuits that have heavy motors, such as refrigerators and power tools, because they create a brief power surge upon start-up.
- *S fuses* come in two pieces: a separate metal base, which screws into the fuse outlet, and the fuse itself, which matches the base. This system helps prevent the wrong fuse from being used on a particular circuit since the fuse and base must match.

When the Lights Go Out

When electricity fails in only one part of the house, it is probably because of an overload or short circuit in the system. An *overload* occurs when too many appliances or lights are plugged into one circuit. A *short circuit* is caused by a bare electrical wire touching another bare wire or a piece of metal. In either case, the problem has tripped the breaker or blown a fuse. You can restore electricity by resetting the breaker or replacing the fuse, but first, unplug all appliances and lamps on the circuit. If the electricity fails again while everything is disconnected, call an electrician—the problem is in the wiring.

If the electricity remains on after you have reset breakers and/or replaced fuses, replug appliances and lights one at a time. Check for frayed cords and melted plugs or sockets that could be the source of a short. Do not reconnect any damaged cords or plugs.

Replacing Electrical Cords

When electrical cords on lamps or small appliances become broken or frayed, replace them with one of the same length, gauge, and type as the original cord. Avoid making a quick fix using electrical tape.

How to replace a wire or cord will depend on the appliance you are repairing. Begin by removing the screw or screws on the appliance housing or backplate to access the internal electrical connections. Disconnect the old cord by unscrewing the terminal or terminals where the cord is attached. Strip ½ inch of the insulation from the wire ends of the new cord, twist the wire strands together, and then hook them clockwise around a terminal. Tighten the terminal screws and replace the housing or backplate.

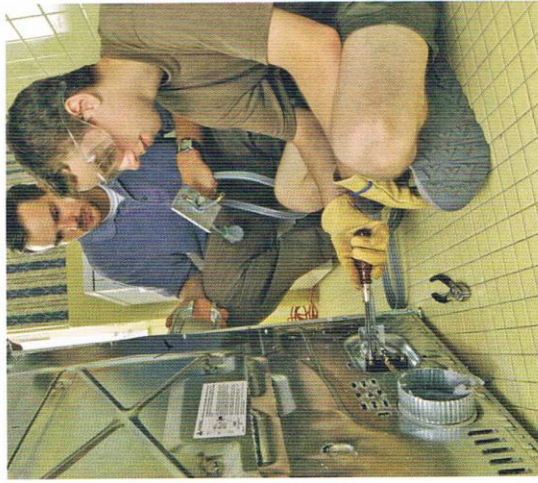

Repairing Plugs and Sockets

When sockets or plugs don't work, it is often because a wire has become detached from a connector screw. Fix this problem by simply reattaching the wire and tightening the screw. Worn or damaged sockets and plugs, however, should be replaced. You can buy new ones at a hardware store for a minimal cost.

Replacing a Standard Plug

Follow these three steps to replace a standard plug:

- Step 1**—Unplug the appliance. Cut through the cord just behind the old plug. Slide the cord through the back of the new plug. Split the wires and tie them into an underwriters' knot by forming a large loop with each wire and inserting the end of each wire through its opposing loop. To tighten the knot, pull on the ends of the wires.
- Step 2**—Pull the knot into the plug's base. Strip $\frac{3}{4}$ inch of insulation from the end of each wire.
- Step 3**—Wrap the insulated portion of the wires around the prongs to form an S. Wrap the exposed wires around the terminals in the same direction in which the terminals turn. Tighten the terminal screws with a screwdriver. If the plug has a cardboard insulator, slip it in place over the prongs to protect the wires.

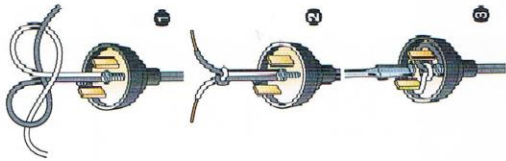

Repairing a Socket

A socket is easy to take apart. If the outer shell doesn't readily slip off the socket cap, apply pressure with a screwdriver where the word "press" is marked. Pull the cap and insulating sleeve away as you press.

If a wire connection has come loose at a terminal screw, rewrap it clockwise and tighten the screw. If the socket is broken, replace it with a new one.

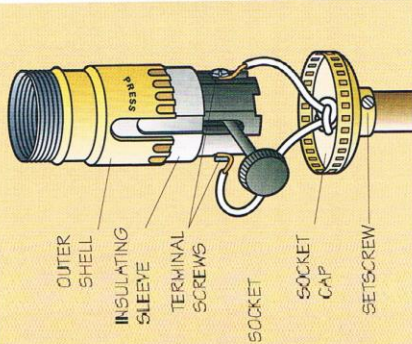

Replacing a Wall Switch

Note: This project is for a single-pole switch controlling a light, not for multiple switches controlling a light.

A single-pole switch that controls a light from one place has two brass-colored terminals on the switch side. Hot wires are connected to these terminals. *Before you begin, turn off the power to that switch at the main service panel.* Remove the coverplate and gently pull the switch out. Don't touch any bare wire ends or switch terminals.

Use a voltage tester to make sure there is no voltage: Touch one probe of the tester to one of the screw terminals and the other probe to a ground source, such as the metal shell of the outlet box. The tester should not light up. Be sure to check both wires connected to the switch.

Disconnect the two switch wires and the ground wire (a bare copper or green wire), if present. Connect the new switch to the two hot wires you just disconnected. Attach the ground wire to the new ground screw using a wire connector. Remount the new switch and return it to the wall. Tighten the screws and replace the switch cover.

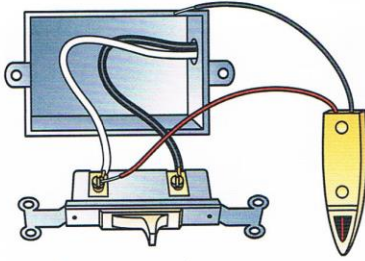

Turn off the power before working with any switch.

Replacing a Wall Outlet

Note: Always replace an outlet with one of the correct amperage and voltage rating.

Step 1—Turn off the circuit or main power switch, and use a meter or circuit tester to make sure that the power is off.

Step 2—Remove the coverplate and unscrew the receptacle (plug).

Step 3—Remove the wires, noting where they are connected (reconnect them in the same order). If a tab is separated on the line side of the plug, note the wiring, replace the wires, and remove the tab as on the original switch. Remove this tab if a switch will control the plug for a lamp that will be operated by the switch.

Step 4—Install the ground wire.

Step 5—Install the receptacle and coverplate.

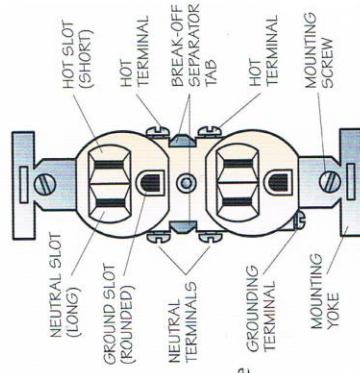

Grounded three-slot 120-volt duplex outlet

Water Works

When it comes to plumbing problems, the best tools are a "plumber's helper" (a plunger), a little common sense, and a willingness to ask questions at a hardware store. Before you know it, you will be able to handle most basic plumbing jobs.

Safety First

- If you use chemical drain cleaners to unclog a drain, wear protective gloves and goggles to avoid injuring your skin or eyes.
- Keep power tools away from areas where water has leaked. Try to contain spilled water with towels or a wet-dry vacuum cleaner.
- If a clogged toilet contains raw sewage, or if the sewage has overflowed onto the floor, wear rubber gloves during cleanup to avoid the risk of contamination. Make sure to sanitize the affected areas afterward with bleach or disinfectant.



Plumbing bolts, nuts, screws, and threaded connections can be hard to loosen, especially when they are corroded. Remember this saying: "Clockwise is lockwise," and then be sure you're twisting in the opposite direction.

Preventing Clogs

Help keep your household drains flowing freely by making sure not to pour grease down them. In the bathroom, keep drains as clear of hair as possible. Use a drain strainer if possible. For regular maintenance, try this noncaustic and safe alternative to commercial drain cleaners: Pour 1/4 cup of baking soda and 1/4 cup of white vinegar down the drain; let it sizzle for several minutes, and then flush with a kettle of boiling water.

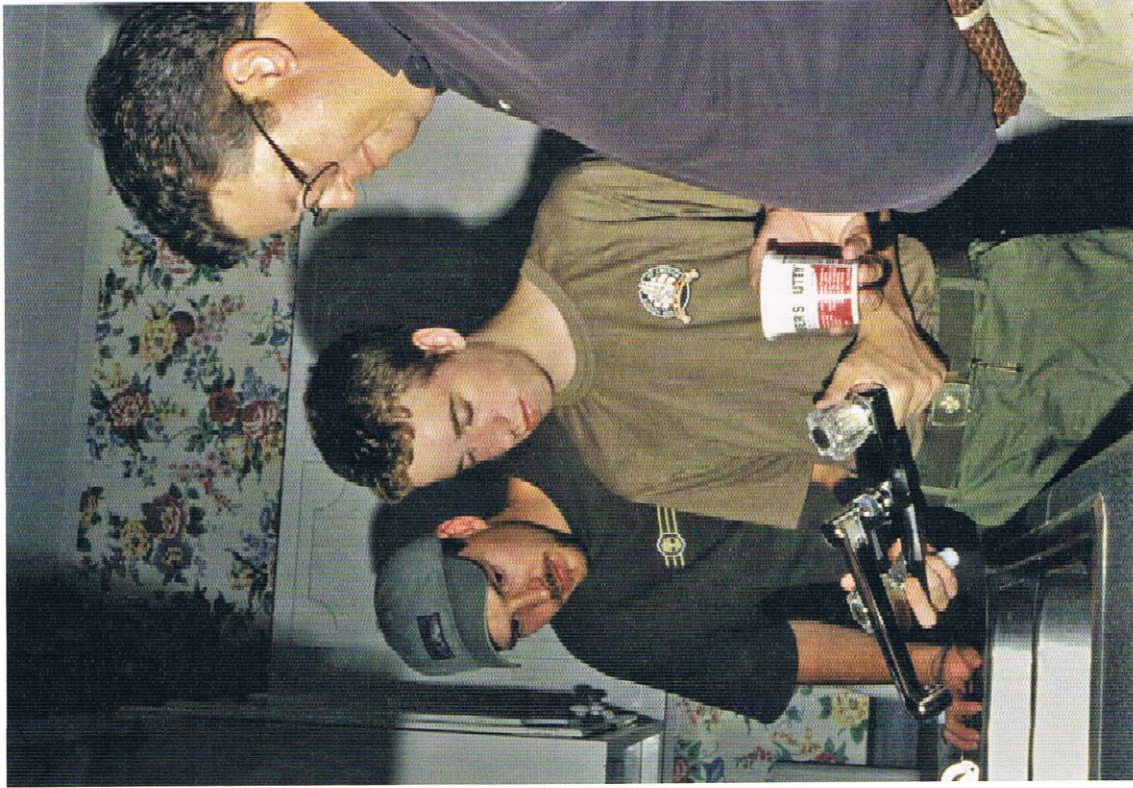

Clearing Clogged Drains

The drainage systems in homes have two parts: *traps* in the shapes of a drum or J, S, or P, plus pipes to which the traps are connected.

When water or waste won't run out of a sink, tub, or toilet, debris is blocking the route in the pipe or trap. Try these remedies, in the order following:

1. **Remove the stopper or drain cover** and clean off any accumulation of soap scum and hair with paper towels and pipe cleaners.
2. **Try a commercial drain cleaner** on slow-draining sinks or tubs. Give it plenty of time to work—a few minutes longer than specified on the package. If the drain is still slow, don't risk a chemical burn by immediately trying repairs involving augers or trap removal. Continue to use the sink or tub so the chemical will wash away completely. Try further repairs in a day or so.

3. **Loosen a clog with suction.** Petroleum jelly applied to the base of a plunger helps seal it to the sink. Block the overflow or adjoining sink drains with rags. Fill a sink with enough water to cover the plunger and create more of a seal. If you are plunging a toilet, leave enough water in the toilet to create a seal (you can't plunge a dry toilet), but not so much that it overflows when you plunge. Use steady, rhythmic, and forceful downward strokes to clear the clog. Stroke 10 times, and then test the flow. Repeat the procedure three to five times, if necessary. Once the water drains freely, flush the drain with hot water for five minutes.



The bellows-style plunger for a toilet (left) has a narrowing plunging end to fit inside the bowl and create a better seal; those designed for flat drains (right) have a flat bottom to better seal a drain in a sink, tub, or basin.

Use caustic commercial drain cleaner only as a last resort, and never in a completely clogged drain. These products are highly corrosive to plumbing systems.

4. **Insert a "snake," or auger, into the drain** (or a plug in the pipe) to dislodge a persistent clog. If you don't have an auger, you can make a crude one with a straightened coat hanger. Use towels underneath to protect the surface from chips or scratches. Don't be too forceful with the auger. It could break a plastic pipe, or a homemade one could break off in the drain.
5. **Remove the trap.** If all else fails, place a pail under the trap and open it with an adjustable wrench. Clean the trap with a small brush or by running a cloth through it. Before replacing the trap, clear the pipes that attach to either side of the trap using a snake. Replace the trap. If the drain flows freely, flush it with hot water.

Fixing Leaky Faucets

Leaks are the most common problem with faucets. Most leaks are caused by worn washers or packing. Do-it-yourself repairs are simple and inexpensive, unless you forget the first rule of faucet repair: **Turn off the water before you start!** Usually, you will find shutoff valves under the sink. If you don't, or if the water still runs from the faucet after you shut it off under the sink, have an experienced adult or a plumber help you turn off the water supply at your home's main water-supply valve.

There are several kinds of faucets: compression, single-lever, and cartridge (hollow metal or plastic inserts that seal against the spout or faucet body). A *compression faucet* is one of the most common types.

Faucet repair kits are sold by brand and model number at plumbing supply and hardware stores. If you don't know the brand or parts you need, divide the parts into plastic bags, maintaining the assembly and labeling the bags "hot" and "cold." Take the old parts with you to the store.

Always make sure that water is shut off by opening the faucet. If water does not completely stop running, an experienced adult or a plumber may need to rebuild or replace the shutoffs.

Parts that can be replaced in most compression bathroom, kitchen, and laundry faucets include the seat, washer, washer screw, and packing. Repair kits usually contain all washers, O-rings, and packing string for a faucet, and you should replace all the old parts with the new ones. Begin disassembly by locating the screw that holds the handle. Sometimes the screw is hidden by the escutcheon, or decorative cap, which indicates "H" for hot or "C" for cold. Pry the cap off with the tip of a slot screwdriver. Protect chrome finishes by padding them with a cloth while you work.

As you disassemble the faucet, carefully lay each piece on a towel in the order that you remove it so you will know how to reassemble the object after you have replaced the old parts. Clean any dirt or corrosion off permanent parts with an old toothbrush or fine steel wool before reassembly. Dip the brush or steel wool in vinegar to help dissolve mineral deposits on parts.

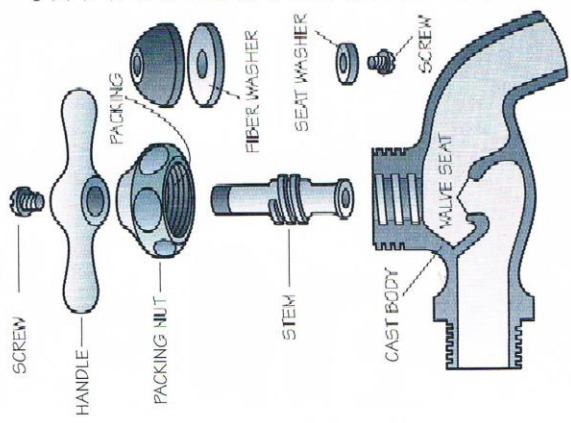

Compression faucet



Easy Toilet Repairs

Easy Toilet Repairs

All gravity-assist flush toilets operate basically the same. When you flush the toilet, the handle lifts an arm or chain that raises the flush valve, which can be either a ball (in older toilets) or a flap-per. Tank water flows out of this opening to flush the toilet bowl. The float ball rides the water level down the tank and turns on the water-intake valve in the ballcock. At the same time, the flush valve drops back into the opening, sealing it to fill the tank again with fresh water.

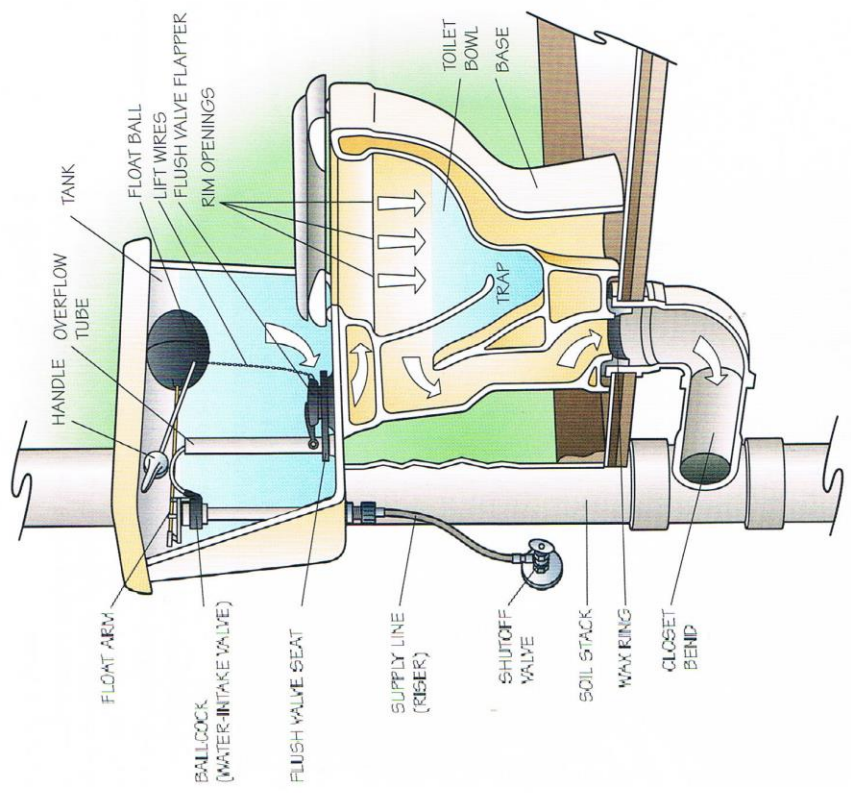

A gravity-assist flush toilet with a float ball

Another kind of toilet is becoming more popular, especially with federally mandated standards for how much water a toilet can use in one flush. Pressure-assist toilets "push" the contents out of the toilet bowl rather than using the pulling action of gravity in the gravity-assist toilet. Inside the china toilet tank, you won't find any standing water, as in a gravity-assist toilet, so one advantage is that the tank of a pressure-assist toilet never "sweats" in heat and humidity.

Clogged Toilet

If the water in a toilet bowl rises to the rim or overflows, something is probably blocking the channel. Follow these steps to try clearing it with a plunger.

Step 1—Close the flush valve by hand, putting the flapper or ball stopper back in the closed position. Then turn off the shutoff valve at the side of the toilet.

If the clog

persists, it's

probably time

to call a plumber.

Step 2—Drain excess water from the bowl with an old cup or can. Leave enough water to cover the plunger cup.

Step 3—Stand in front of the toilet and plunge vigorously about 10 times.

Sometimes you can see obstructions using a small mirror and flashlight. With the mirror, you can look under the rim to see whether the flush holes are clear. If they aren't, try cleaning them with the hook end of a straightened clothes hanger. You also can inspect the top of the trap with the mirror and flashlight—but empty all the water out of the toilet bowl first!

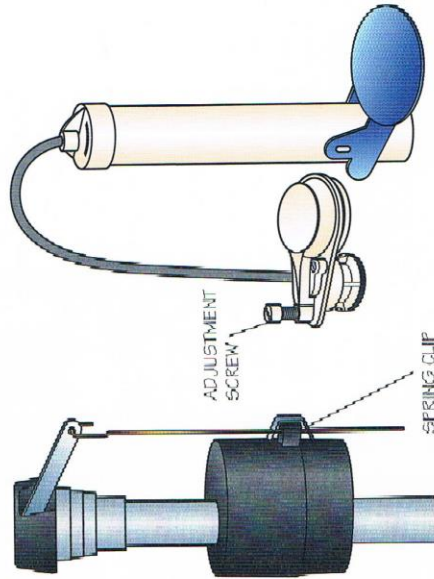

The insides of gravity-assist toilets may vary. With a floating cup ballcock (left), the position of the floating cup controls the water level. You can adjust the water level by moving the spring clip. To make water-level adjustments with the floatless ballcock (right), simply turn the adjustment screw.

Running Toilet

A running toilet, one that is constantly letting water into the tank, is both irritating and wasteful. It is also one of the easiest and least expensive toilet problems to fix. Drain the tank first by turning off the water supply and then flushing. Remember to turn the water supply back on when repairs are done.

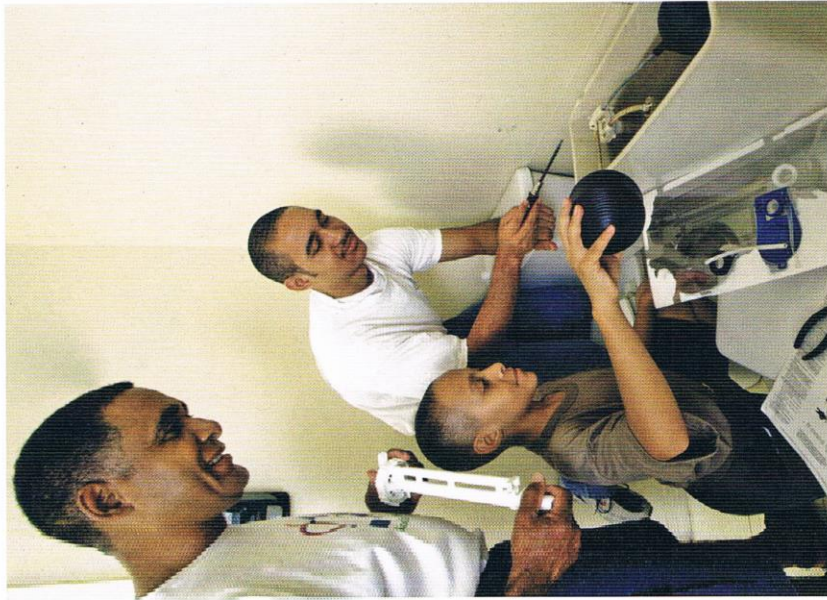

Running toilets can have several causes and easy remedies:

Problem	Solution
Leaking float ball	Unscrew the ball to remove it, and install a new one. If a new one is temporarily unavailable, empty the leaky ball, cover it with a plastic bag, and secure the bag with tape or a rubber band.
Float arm	If the rod is keeping the water-intake valve open, bend the rod up or down slightly, or adjust its screw.
Leaky water intake	Clean corrosion off washers and other valve parts with a toothbrush dipped in vinegar, or install new ones.
Faulty flush valve seat	Raise the valve and buff the seat with steel wool. Remove only corrosion, not any metal.
Worn flush valve (flapper)	A replacement flapper slides over the overflow pipe or hooks onto lugs. If replacing a flush valve ball, unscrew it from the lift wire. Make sure that the new valve ball falls squarely into the seat of the flush valve.
Toilet tank overfills	Examine the flush valve; the repair may be as simple as replacing the flap.
Water is going over the overflow tube	Adjust the float arm, adjustment screw, or spring clip. If the water continues to fill past the overflow tube, replace the fill valve.

Repairing Leaky Hoses

For temporary repair of a pinhole leak in a hose, dry the hose and stop the hole with a heavy coat of rubber-base cement. Wrap the hose with a spiral of plastic electrician's tape.

For a more permanent repair, buy a metal or plastic hose coupling that is the same diameter as the hose. Cut the hose cleanly and squarely; a ragged cut may cause a leak. Install the coupling according to package directions. For some, you will need a hammer, but some are screw-on or clasp-on connections.

To fix a leaky connector, unscrew it, insert a washer, and replace the connector.

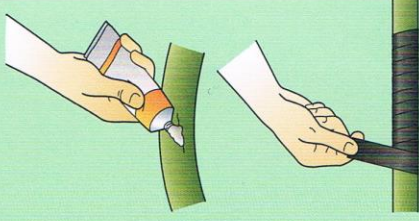

Fixing Sprinkler Heads

Sprinkler heads normally are flush with the lawn so lawn mowers don't come in contact with them.

Water pressure raises the center portion of the head when the system is turned on. Turning the small screw at the center of the head increases or decreases the flow of water.

Grass, mineral deposits, and dirt can clog spray heads. To clean them, lift the head by hand and insert a fine wire into the jets. Never use a toothpick because the wood can break off in the jets. Some spray heads unscrew for easier cleaning.

To replace a sprinkler head, remove the old core head with a special core wrench, screwdriver, or adjustable wrench. The threads turn counterclockwise.

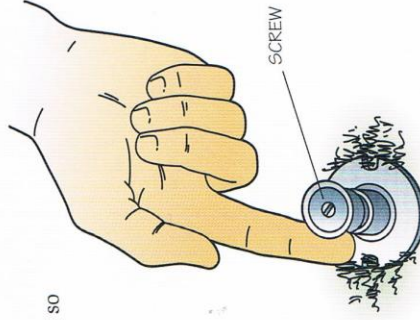

Wall Works, Caulking, and Weather-Stripping

Everyone likes a freshly painted home that's warm in the winter, cool in the summer, and dry all year 'round. Best of all, well-maintained walls hold up longer and keep energy costs down.

Caulking Cracks and Joints

Among energy-saving products, caulking probably is the least expensive and most effective. All you need is a caulking gun and the proper sealant.

Check your home for missing and cracked caulk. Insert a putty knife into old caulking. If it is still gummy, leave it in place. If the caulking cracks, remove it with a putty knife and wire brush. You want a dry, dust-free surface that's slightly roughened so the new caulking adheres well. Seal all these areas:

- Around windows and doors, fixed storm windows, and cracks between door thresholds and stoops
- On the exterior of your home—along the bottom of siding where it meets the foundation, and around any basement windows
- Between joints, splits, and cracks in siding
- At dormers and roof flashing, gable vents, and roof vents
- At power and cable entrances and exits
- Between dissimilar materials such as wood and masonry, masonry and metal, etc.

When the air inside an insulated home is warmer than the air outside, the warmer air releases moisture as it passes through the insulation and condenses into water when it reaches the colder exterior wall. A vapor barrier of aluminum foil or heavy plastic sheeting stops this vapor from moving beyond the interior surface of the insulation, so it never gets to a colder wall and condenses.

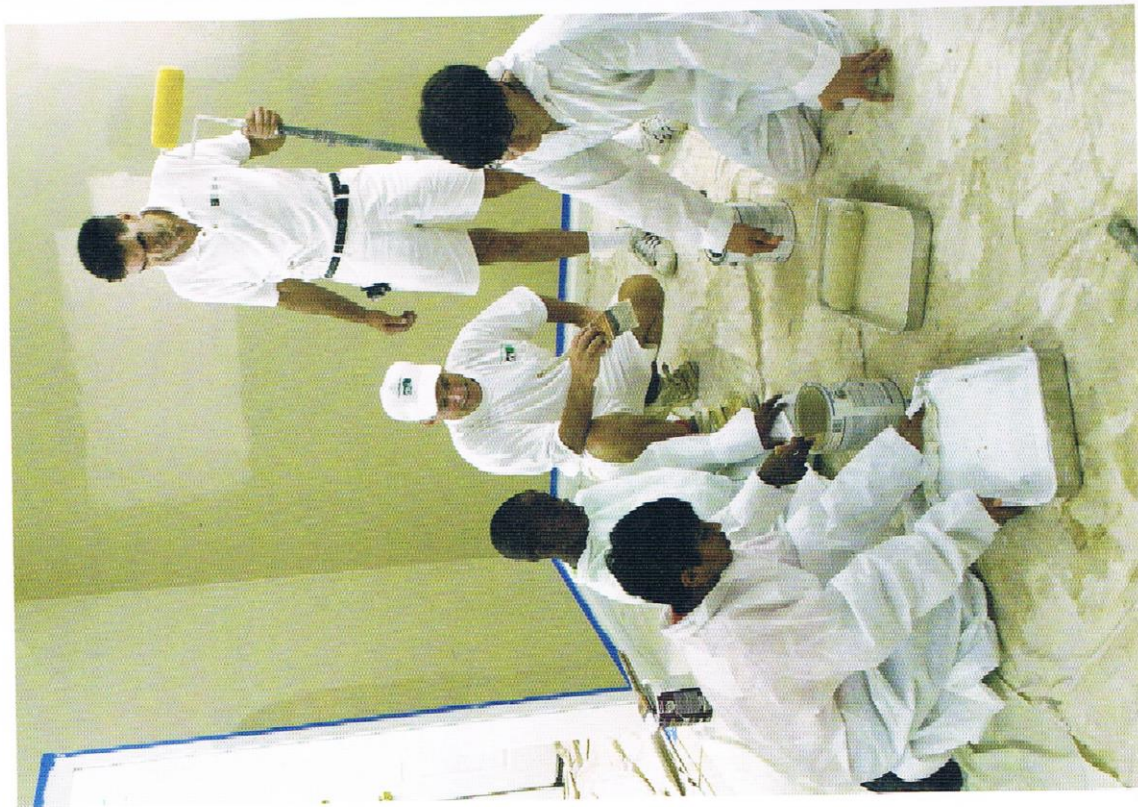
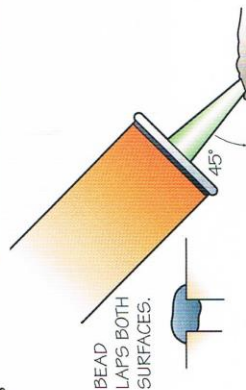

Caulking comes in many varieties, colors, and prices. Ask your hardware dealer for the right kind for the job you are doing. Fill wide or deep cracks with fiberglass insulation, a tarred rope called *caulk*, or expandable foam insulation.

If you are using a caulking cartridge, cut the tip at a 45-degree angle and hold the gun at the same angle. Experts disagree over whether you should “push” or “pull” a bead of caulking as you work. Either way, mow slowly so that the caulking fills the opening completely and overlaps both surfaces. Wipe away excess caulk with a damp rag or wet finger.

Use the same technique to prevent water leaks around sinks and tubs. For those areas, sealant is available in smaller dispensers.

Painting Walls and Ceilings

A fresh coat of paint will brighten any room. Most of the work is in adequate preparation. Paint the ceiling first, then the walls, floorboards, doors, and window trim.

Note: For more in-depth information on painting walls and ceilings, see the *Painting* merit badge pamphlet.

The Right Paint for the Project

There are lots of different kinds of primers and paints. Check with someone at a paint store to make sure you are getting the right paint for the project. Also, always read the product label and closely follow the manufacturer's safety guidelines. If possible, obtain the MSDS (material safety data sheet) for the product. Contact the manufacturer (check the product label) or search online (with your parent's permission).

- **Latex paints** are water-thinned and can be cleaned with soap and water. They are good for walls and ceilings.
- **Alkyd paints** are oil-based and have to be thinned and cleaned with a solvent such as turpentine. They are particularly useful in baths and kitchens.
- **Enamels**, available in both latex and alkyd bases, have a harder surface than most interior paints.

Safety First

- When painting, make sure your work area is well-ventilated.
- Lead-based paint is a major source of lead poisoning for children and can also affect adults. If you are removing existing paint that you think may contain lead, get it checked by an expert. Avoid activities that will disturb or damage any lead-based paint and create dust. State and local health departments and housing authorities may have lead poisoning prevention programs and information about testing labs and contractors who can safely remove lead-based paint.
- Basements, garages, and storage areas can contain many tripping hazards and sharp or pointed tools that can make a fall even more hazardous. Have light switches at each entrance to a dark area. Keep an operating flashlight handy in case of a power loss.

Proper Use of Hand Tools

Common hand tools include rags, sandpaper, abrasive pads, scrapers, broad knives and putty knives, wire brushes, and chipping hammers. Before using a scraper, brush, knife, or hammer, wash away oil and debris with detergents or solvents. Brush away or vacuum particles afterward.

Remember to follow these safety guidelines:

- Always wear goggles and gloves.
- Keep tools in good condition.
- Do not leave unused tools lying around.
- Never throw tools; use tools only for the purpose they were intended.
- Avoid using tools that make sparks near combustible liquids or vapors.
- Properly dispose of used rags frequently, and always at the end of each day.



Common Hand Tools

- Scrapers remove paint from any type of surface.
- Wire brushes clean debris from all types of surfaces.
- Use broad knives and putty knives to apply patching material and to scrape loose paint.
- Chipping hammers chip away layers of loose surface material.



Application Equipment Selection and Usage

BRUSHES

Use brushes for cutting in and painting areas that the roller can't reach. Try to use only quality brushes. Some brushes may be more expensive, but they may be worth it in the end because they will last longer and using them will give a better overall performance as you apply paint.

A paintbrush consists of four parts: the handle, the bristles, the epoxy setting that binds the bristles together, and the ferrule, which attaches the bristles to the handle.

Select a brush that is appropriate for the job and coating type. Use a synthetic brush when painting with latex paints. Make sure the brush holds the bristles tightly. Use natural bristles when using oil-based paints and varnish.

Choose brushes suitable in width for the specific project. For large areas, use a wall brush. Select a narrow sash brush for smaller, hard-to-get-to areas. For varnishing, use a thinner brush.

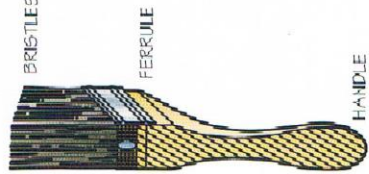

ROLLERS

Using rollers gets a paint job done quickly. There are two types of rollers: the more common dip roller, which is dipped into the paint for application; and the fountain or pressure roller, which has a hollow core where the paint is stored and pressure-fed through small pores to the outer fabric.



The fibers on the roller covers are known as the *nap*, usually described by the fiber length, which ranges from 1/4" to 1 1/4". Generally, the rougher the surface you are painting, the longer the nap you should use. The longer nap makes it possible to work paint into irregular surfaces such as concrete block and highly textured walls like stucco.

Other equipment used with rollers includes extension poles, which can make it easier to reach higher places; trays; mesh grids, which are immersed in 5-gallon paint buckets to serve the same purpose as the rough edges in a roller tray; and special tools for cleaning roller covers.

The smoother the surface you are painting—and the smoother the finish you want—the shorter the nap you should use.

Is Your House Lead Free?



Lead-based paint can cause serious health problems.

Removing it is such a high-risk job that it is best left to a professional. Structures built prior to 1978 are likely to have been painted with lead-based paint. Ask your parents when your house was built. If it was before 1978, or if they are not certain when it was built, do not attempt to use your house as a project. Find something else.

Never attempt to remove lead-based paint yourself.

Contact the Environmental Protection Agency for more information (see the resources section in this pamphlet).

PADS

Paint pads are rectangular foam pads covered with fabric and set in a plastic holder. These pads, with their straight sides, are useful for painting areas like the space between the ceiling and doorframe as well as exterior siding.

Preparation

Preparing for painting is as important as the painting itself. If you don't prepare correctly, the paint may not bond well to the surface.

Fill any minor cracks or holes with *surfacing compound* and allow it to dry thoroughly. Use sandpaper to level and smooth the patches. Because surfacing compound shrinks as it dries, you may need a second application. You may also need to texture the second application to match the wall or ceiling texture. Again, allow your work to dry thoroughly before painting.

Make sure that all surfaces are clean, dry, and free of dust. This is particularly important—even fingerprints can prevent paint from adhering well! Use a heavy-duty household detergent to wash all areas to be painted.

Cover light fixtures and doorknobs with plastic bags, and protect floors and furniture with drop cloths. Use masking tape around the edges of woodwork. Remove switch plates and tape heavy paper over jacks, plugs, and switches, or disconnect the power to the room.

Here is how to determine the amount of paint needed for a rectangular or square wall. Multiply the height and the width.

Example: $8' \text{ height} \times 20' \text{ width} = 160 \text{ square feet}$

To determine the area of a room, multiply the height and the width for each wall, then add the total for each wall.

Example:

$8' \text{ height} \times 20' \text{ width} = 160 \text{ square feet for wall 1}$
 $8' \text{ height} \times 20' \text{ width} = 160 \text{ square feet for wall 2}$
 $8' \text{ height} \times 15' \text{ width} = 120 \text{ square feet for wall 3}$
 $8' \text{ height} \times 15' \text{ width} = 120 \text{ square feet for wall 4}$
 $160 + 160 + 120 + 120 = 560 \text{ square feet total}$

You will need enough paint to cover 560 square feet. You probably will need a little less than 2 gallons for the room.

Painting Basics

- Read the label on the paint can before purchasing. Calculate the area you want to paint and compare that with the label to know how much paint to buy.
- Stir paint thoroughly. Strain any impurities through cheesecloth or old nylon hosiery.
- “Cut in” edges with a brush—that is, paint a strip about 2 inches wide in corners and along edges where the same color of paint will meet.
- Use a sturdy ladder to reach high areas.
- Use a roller for walls and ceilings, with an extension rod for high areas. Pour the paint into a roller pan, about half an inch deep. Distribute the paint evenly around the roller.
- Work across the narrowest part of ceilings. Spread paint on the walls from the top down.
- With a full roller, spread paint in a large W or M pattern on one section of a wall or ceiling. Go over the area in several directions and smooth all edge marks from the roller. Use up all the paint on the roller before reloading (resoaking) it.

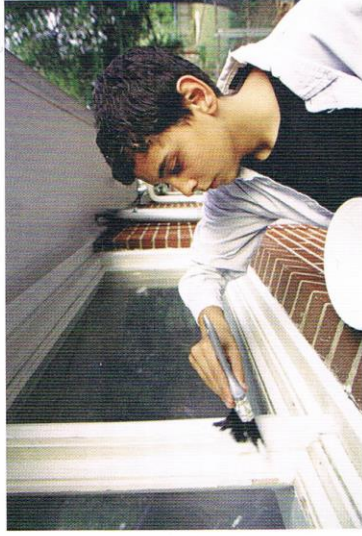

Cleanup

- Keep a damp rag and a dry rag handy while you're painting. Wipe away drips and splatters as they occur.
- Clean latex paint out of a metal roller pan with soapy water. Disposable plastic liners are available for metal pans. If the pan is plastic, let the paint dry and peel it away later.
- Clean paintbrushes thoroughly after each use.



Waterproofing a Basement

These instructions are for unpainted, untreated basement walls. If your basement is painted, you must strip off the paint before you begin waterproofing.

Step 1—Prepare the walls as for painting, that is, cover all electrical sockets, etc.

Step 2—Using a broom or stiff scrub brush, clean any mildew from walls with a mixture of 3 quarts hot water, ½ cup trisodium phosphate (TSP, available at hardware stores), and 1 quart chlorine bleach. Wear gloves as you work with this mixture.

Step 3—After the wall is clean and dry, use a paintbrush to apply a premixed, concrete-based latex waterproofing compound. Make sure you fill in all the tiny cracks and pores.

Step 4—Allow the wall to dry, and apply a second coat.

Environmental Responsibility

Using chemicals comes with a risk for polluting the environment. Take care in all steps of painting and handling materials. Always dispose of any chemical material according to the manufacturer's instructions and local laws.

Air and Water Pollution. Local, state, and federal regulations apply to hazardous material disposal, so ask your merit badge counselor about regulations that may affect your project. The local Environmental Protection Agency office (look in the blue pages of the phone book) can tell you more about environmental regulations in your area.

Never remove old paint that may contain lead. Doing so may harm the environment and put yourself and others at risk. Particles can disperse into the air or settle on the ground, threatening the health of anyone nearby. Lead-contaminated earth can be lethal. Contact a qualified professional painting contractor for projects where lead-based paint may be present.

Proper Disposal Procedures. Sweep or vacuum any particles of old paint you remove, and properly dispose of this waste. To dispose of leftover paint, remove the lid and allow the paint to completely harden. Replace the lid and throw the can away. This way, the paint will not escape the can and contaminate the environment.

Weather Stripping

Doors and windows that are tightly fitted and properly weatherstripped help prevent costly heat loss from a home. Weather stripping comes in a variety of materials, including metal, vinyl, and foam. For heavily used doors and windows, nail-on weather stripping holds up better than self-adhesive types, saving time and money in the long run.

Replacing Weather Stripping on a Door

Jamb weather stripping seals the space along the sides and top of the door. *Sill weather stripping* keeps drafts or water from entering underneath the door.

JAMB WEATHER STRIPPING

Step 1—Always start with a clean, smooth, and dry surface. Remove old weather stripping if necessary. Clean the door jamb with soap and water (especially if you are using self-adhesive stripping). Allow the jamb to dry completely.

Step 2—Cut the top piece of weather stripping first, fitting it to the corners of the doorstops. Then cut the side pieces to ensure a snug fit at top and bottom. Allow for a gap at the strike plate by the door knob.

Step 3—Start with the top piece. If you are using the nail-on type stripping, nail the trim to the jamb using 4d nails. If you are using self-adhesive stripping, position the weather stripping before peeling off the paper backing. Check to be sure that the weather stripping compresses slightly against the closed door. If it compresses too little or too much, it does no good.



SILL WEATHER STRIPPING

After the jamb weather stripping is installed, seal the bottom of the door with a door sweep. High carpeting or an uneven floor may block a standard door sweep. In these cases, consider installing a hinged sweep instead.



Step 1—Cut the sweep to length. When working on the side of the door with the stops, cut the material 1/8 inch short so that it clears the stops.



Step 2—Adjust and position the sweep to seal firmly but not too tightly against the threshold.



Step 3—Tack both ends of the sweep to the door. Use screws or nails to secure the sweep in place.

Replacing Weather Stripping on a Window

When weather-stripping windows, gasket-type materials are easy to install but may wear out quickly. It should be used only along the sash where friction will not occur. Always start with a clean, dry surface.

Pressure sensitive weather stripping, such as the self-adhesive type, should be used only on the areas where friction does not occur. On windows, this means it can be used on the upper sash and lower sash, but not on the sides. If you were to apply pressure-sensitive weather stripping to the sides, opening and closing the window would be difficult and cause the weather stripping to pull loose.

GASKET-TYPE WEATHER STRIPPING

Rolled vinyl and felt are the most common choices for gasket-type weather stripping. Felt weather stripping must be installed on the inside of windows. Other types can be installed on the exterior, where they are less obvious and provide a better seal.



Step 1—Cut the weather stripping to the length of the sash.

Step 2—Attach the weather stripping so that it compresses slightly when the window is latched.

For *double-hung windows*:

Step 1—Attach the strips to the outside face of the sashes.

Step 2—Seal between the sashes by attaching a strip to the bottom of the upper sash.

Step 3—Seal the top and bottom sashes by attaching a strip to the outside of the upper sash's top rail and of the lower sash's bottom rail.

For *casement windows*, attach weather stripping to the sash or the casing, whichever makes a tighter seal.

In windows, the sash refers to the framework that holds a pane of glass. So, a double-hung window has two sashes, or parts.

Spring Metal Weather Stripping

Some older homes use spring metal weather stripping, which is designed to fit inside window channels or frames. Gasket-type weather stripping can be used in its place. Just follow the instructions in this chapter for installing gasket-type weather stripping.

Flooring Fix-Ups

Keeping up what's underfoot helps the overall appearance of a home and the lasting durability of your flooring.

Safety First

- When repairing or replacing vinyl or linoleum flooring, have an expert check the existing materials to make sure that they don't contain asbestos.
- Keep your working area well-ventilated; adhesives, sealers, and adhesive solvents may contain harmful fumes.



Repairing Vinyl Flooring

Vinyl flooring is available in sheets and tiles. Chemical seam sealers are available for some flooring materials; be sure you purchase the correct kind for your flooring.

Filling Scratches and Dents

Scratches and dents in vinyl flooring can be filled using a paste made with shavings from a scrap piece or extra tile.

Step 1—Scrape the surface of the extra flooring piece with a notched blade to make a powder.



Step 2—Mix the powder with a clear, quick-drying varnish or lacquer.



Step 3—Surround the scratch or dent with masking tape to protect the undamaged floor.

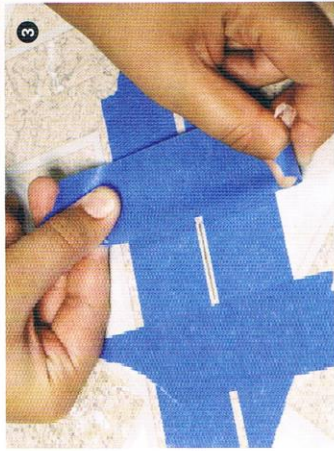

Step 4—Trowel the mixture into the scratch with a putty knife so that it is level with the floor surface. Let it dry.



Step 5—Buff the surface with fine steel wool and boiled linseed oil.



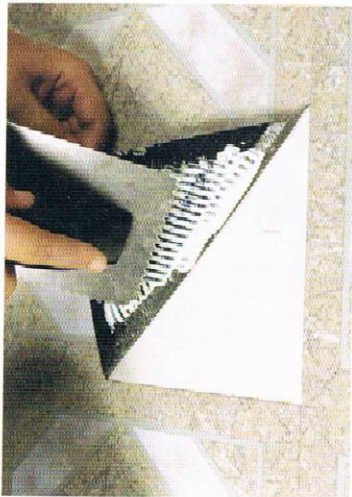

Flattening Curled Tiles

Vinyl tiles sometimes curl at the edges, but you may be able to iron them flat again. First, cover the tiles with paper towels and heat using a *warm*—not hot—iron.

Heat often reactivates the original adhesive. Once the tiles are flattened, cover the seams with foil or waxed paper, and weight down the tiles overnight.

If the tiles recur, heat them again with a warm iron and then gently lift the curled edges and apply new adhesive. Press the tiles back into place and apply seam sealer. Cover the seams with foil or waxed paper and weight them down overnight.

Replacing Damaged Tiles

Replace damaged vinyl tiles square by square.



Step 1—Heat the damaged squares with a hair dryer to loosen the adhesive, and then lift them out with a putty knife or chisel. Be careful not to damage the edges of the adjoining tiles.

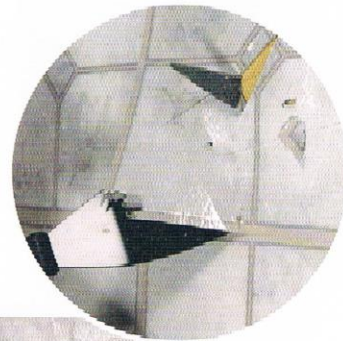

Step 2—Remove all old adhesive from the subflooring with the putty knife or chisel.

Step 3—Place the new tile in the opening, matching the pattern and trimming the new tile to fit.





4

Step 4—Apply the recommended adhesive to the floor. Warm the new tile with an iron or blow dryer and set it in place.



5

Step 5—Cover the new tile with foil or waxed paper and weight it down overnight.

Patching Sheet Flooring

Here's how to replace a worn spot in sheet flooring:

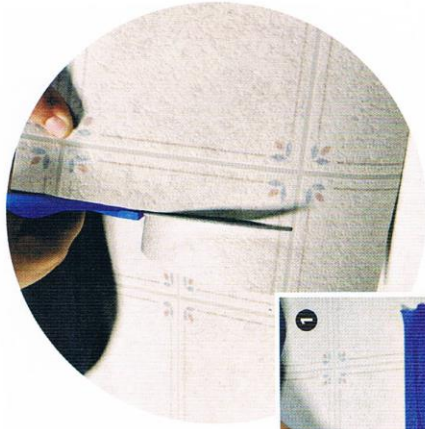

Step 1—Cut a new piece of flooring that is larger than the damaged area. Match the pattern exactly and tape the new flooring in place.



Step 2—Use a sharp knife and carpenter's square to cut through both the patch and the old flooring. Remove the new patch and the surrounding scraps.





Step 3—Heat the old flooring with a hair dryer to loosen the adhesive. Remove the damaged area, working from the worn area to the edges. Be careful not to damage the edge of the patch area. Clean the old adhesive from the subflooring.

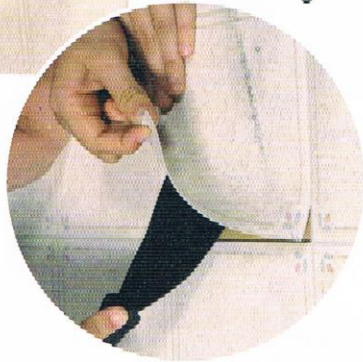

Step 4—Check the fit of the patch and trim it, if necessary. Apply adhesive to the subflooring and insert the patch. If seam sealer is available for that type of flooring, apply it to the edges.



Step 5—Cover the patch with foil or waxed paper and weight it down overnight.

Repairing Concrete and Asphalt

You can follow this procedure to repair cracks and small holes in concrete and asphalt.

Step 1—Clear the crack or hole of all large debris. Undercut the edges with a chisel and heavy hammer.

Step 2—Flush out the remaining debris with water.

Step 3—Apply patching material with a trowel. If you are patching concrete, the patch area must still be wet; if asphalt, the area must be completely dry. Use the edge of the trowel to pack every crevice.

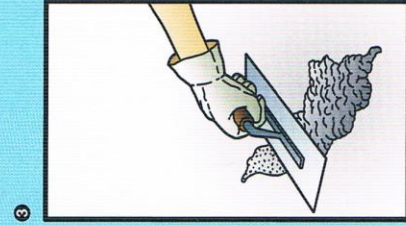
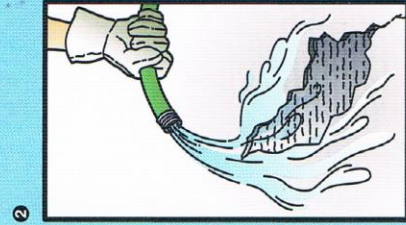

All About Windows

Routine maintenance of your windows will keep them looking good inside and out and can also contribute toward keeping them working well. Often, this can lead to increased energy efficiency in your home—always an important goal.

A *window sash* is the movable part of a window that includes the glass panes and the framework that holds those panes. A *double-hung window* has two sashes.

Casement windows have a hinge on the side and swing like a door.

Safety First



- Make sure that a raised lower window sash is secured when repairing a window.
- Always wear thick work gloves and eye protection when holding glass panes during window-repairing activities.

Repairing Screens

Severely torn or damaged screens should be replaced, but small holes or tears are easy to repair. Repair kits are available at hardware stores.

Cover small rips and holes in a metal screen with a patch that is 2 inches larger than the tear. First, press the damaged wires of the tear against a flat surface. Bend the wires on the edge of the patch into right angles (use a block of wood to help you make a straight, sharp bend). Center the patch over the tear and push the bent wires through the screening around the tear. Turn the screen over and bend the wires flat against the screen with a block of wood.

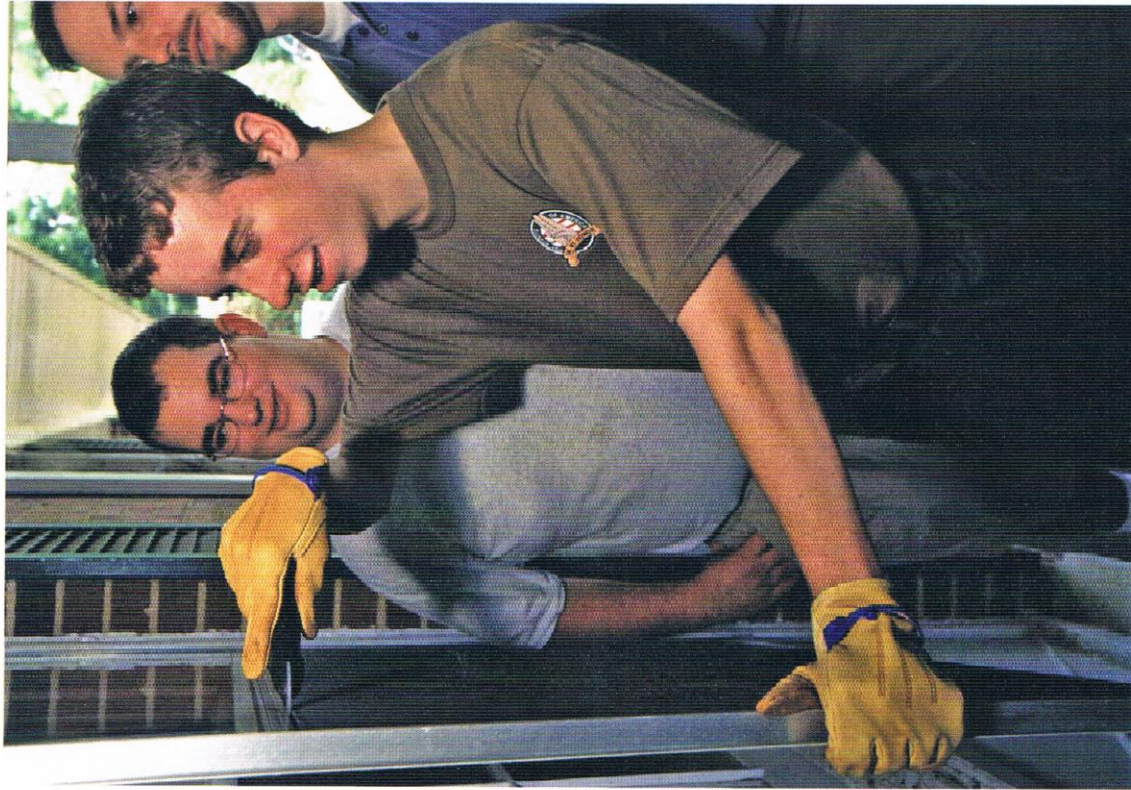
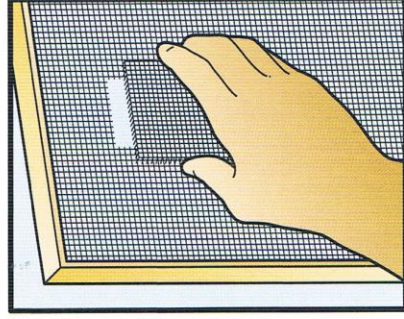

For extra strength, work these wires into the screen again, weaving them back and forth as many times as you can. Your patch will be noticeable at first, but the new wire will weather with time.

For a fiberglass screen, cut a patch that is ½ to 1 inch larger than the tear. Using nylon thread, sew the patch onto the screening. Or you can apply a thin line of epoxy glue around the edges of the patch, smooth it, and then blot any excess before it dries.



Glazing is the process or trade of fitting windows with glass. A *glazier* is the person who cuts and sets the glass.

Replacing Glass Panes

Many homeowners' insurance policies include a provision that pays for a professional to replace broken windows. Before repairing a window yourself, check whether your homeowner's policy has this provision. If not, you can try replacing small panes yourself. But be careful! *Be sure to wear thick work*

gloves and eye protection when working with broken glass. Also, don't break glass that is merely cracked; you might damage the frame.

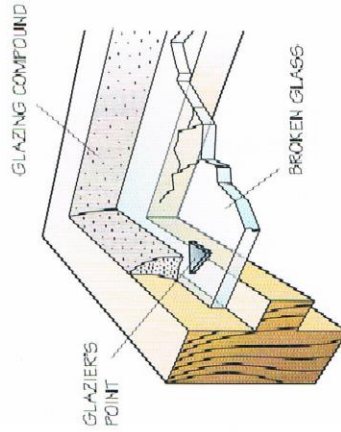

Wood-Frame Windows

Step 1—Remove old glazing compound from the frame. Make this task easier by letting linseed oil soak into the compound for about 30 minutes. Then remove the *glazier's points* (small, flat, triangular metal pieces). Finally, remove the broken glass.

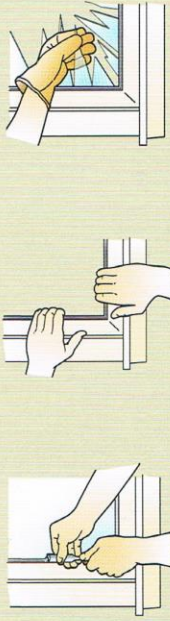

Step 2—Clean the frame, removing all paint and compound. Sand the wood, then add a light coat of linseed oil to help prevent the new compound from becoming brittle.

Step 3—Measure the frame; subtract ¼ inch on each side to allow for wood expansion. Have the replacement glass cut to size, or carefully cut it yourself.



Step 4—Apply a thin bed of glazing compound to the frame's outside edge, then place the glass on this cushion. Install glazier's points every 4 to 5 inches.

Step 5—Lay strips of glazing compound around the frame; smooth it with a putty knife into a 45-degree bevel. Let it dry five to seven days before painting.

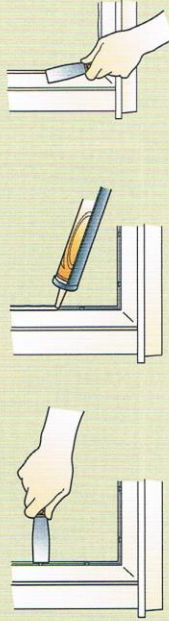

Making a Straight Cut on Glass

Before you try to cut a window pane, practice first on a piece of scrap glass so that you can get a feel for how much pressure you need to use to score the glass. If you hear a rasping sound as you move the glass cutter across the glass, your pressure is just right.



Step 1—Score the glass first with a glass cutter. Lay the glass on a padded surface and place a straightedge against the cut line. Run the cutter against the glass only once, pulling toward you in one smooth motion.

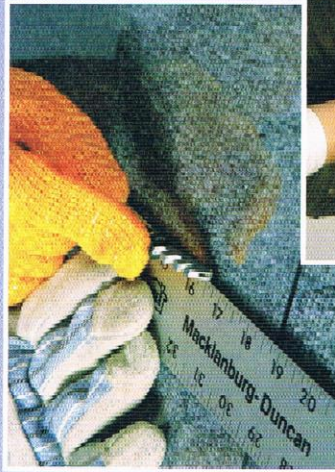

Step 2—Deepen the score by tapping against the underside of the score line with the ball at the end of the glass cutter.



Step 3—Place a thin dowel that is as long as the score line on the work surface, and place the score line directly over it. Press firmly on both sides of the score, and the glass should snap with a clean, straight edge.

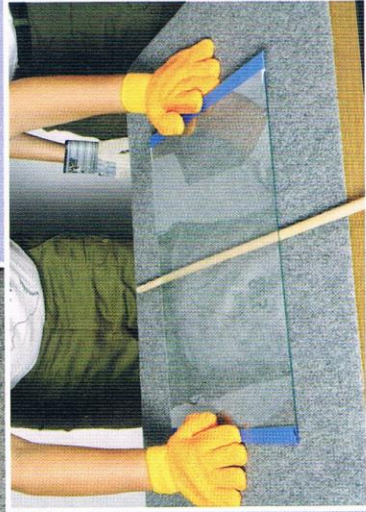

Metal-Framed Windows

Glass can be held in metal sashes in three ways: with flexible spring clips that keep the glass in place (instead of glazier's points), with four plastic moldings that snap into channels in the frame (common with insulated glass), or with rubber gaskets. Talk with a professional or do some research about the kind of sash you have and the best way to remove and replace the glass.

Some metal windows come apart so that you can remove the gaskets and the glass. If rubber gaskets are worn and cracked, buy new ones. Also, make sure you use a glazing compound that is especially formulated for steel or aluminum window sashes.

Installing Rods for Curtains or Drapes

There are lots of different kinds of window treatments—including basic curtains and drapery rods. When installing rods, keep these things in mind:

- Keep rods perfectly level, even when the window isn't.
- Usually, you shouldn't be able to see rods from the outside.
- Bracket placement affects the look of a window, making it appear taller or wider, or both. Decide whether to allow wall space or window area to accommodate the drapes when they are open.
- When determining the height of a rod for full-length drapes, notice where the hooks are placed in the drape. Allow ½ to 1 inch at the bottom so the drapes will not touch the floor or carpeting, even after hanging for a while.
- Once you find the best place for the rod, hammer a small nail lightly into the frame or wall where the top of the bracket will be. Place a yardstick, a long thick dowel, or a metal ruler across the top of the nails. Check the placement with a carpenter's level.

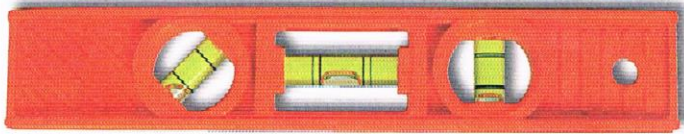

Replacing Blind Cords

It doesn't cost much to replace broken or frayed cords in window blinds. Take the blind from the window and place it on a floor, table, or workbench. Pull tacks, clips, or staples from the top mechanism that holds the pulleys. Blinds will differ in the way they are made, so carefully sketch the cord path before removing the existing cords. When you are sure that you understand how the blind works, remove the old cords and thread the new ones through.

For easier threading, attach the new cord to one end of the existing cord with a small knot and cover it with tape. Pull the old cord until the new one is in place.

Repairing or Replacing Window Sash Cords

Many older wooden windows have a pulley system for opening and closing. Here's how to install a new cord in such windows. Note, however, that experts suggest replacing sash cords with sash chains if the window has a metal pulley with a groove large enough to accommodate the chain.

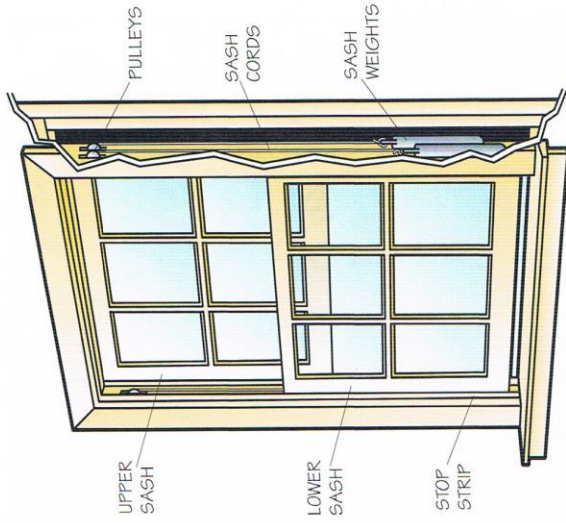

Step 1—Raise the lower sash of the window. With a wide, thick pry bar, pry out the stop strip on both sides of the window and lift the lower sash out of the window frame.

Step 2—Remove the cover to the weight pocket by unscrewing its screws. If necessary, pry off the cover with a chisel. Take the weight out of the weight pocket and remove the old cord.

Step 3—Add about a foot to the total length of the old cord and cut a new cord (or chain) to this length.

Step 4—Push the new cord over the pulley and connect it to the sash. If the cord sticks, tie a small fishing sinker to a string, attach it to the cord, and then drop the sinker over the pulley.

Step 5—Remove the sinker and attach the end of the cord to the sash weight. If you are replacing the cord with a chain, loop the chain through the hole in the weight and bind it tightly with wire. Put the weight into the weight pocket.

Step 6—Replace the pocket cover, then place the sash in the sill. Pull the weight as high as it will go. Cut the cord or chain 4 inches below the hole in the edge of the sash.

Step 7—Tie an overhand knot in the cut end of the cord, fit the knot into the hole in the edge of the sash, and release the slack. The cord will lie in the channel of the sash. If you have used a chain, secure it in the slot with two ¾-inch wood screws fastened through separate links of the chain.

Step 8—Replace the sash in the window frame and nail the stops back on.

Home Furnishings How-Tos

Furniture and decorative objects give your home its unique personality. Should one of these items break, don't trash it—repair it.

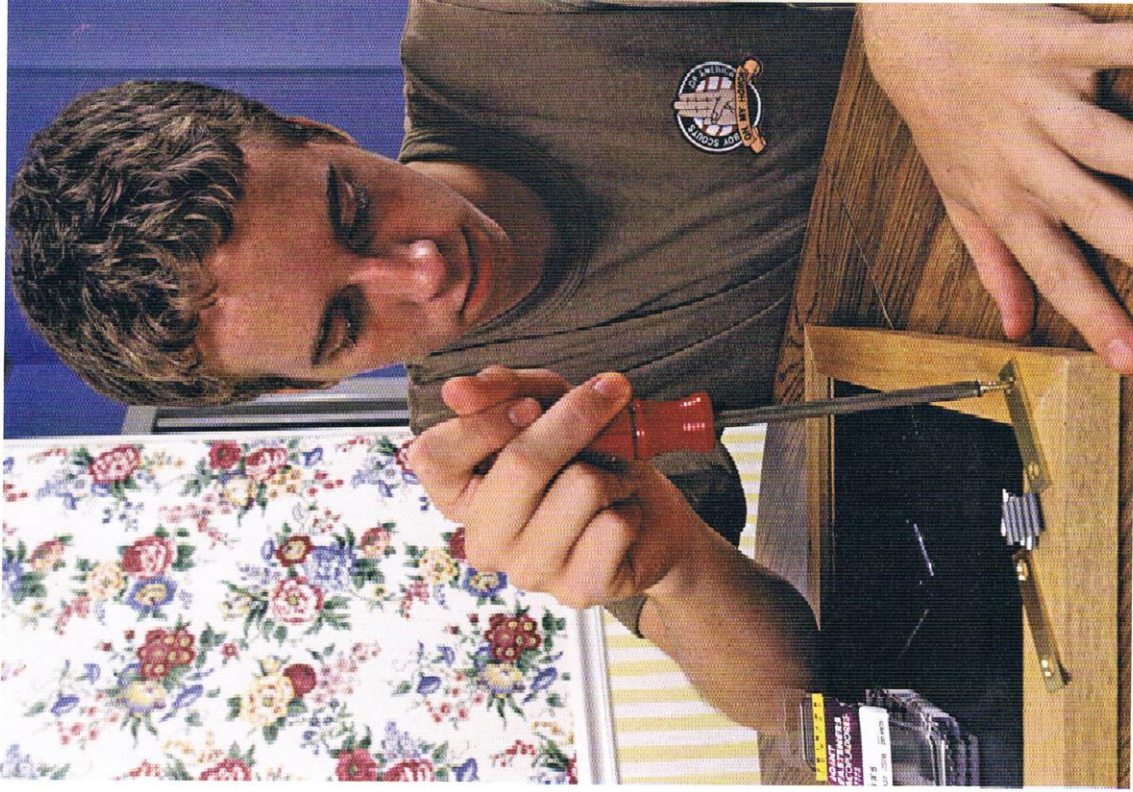

Safety First



- When spray painting, work in a well-ventilated area and wear a paper mask to avoid breathing paint fumes.
- Certain kinds of solder release fumes that can be harmful to your eyes and lungs; therefore, always work with solder in a well-ventilated area.
- Be careful not to let hot solder splash around because it will burn you almost instantly.
- Wear safety goggles when soldering.
- Before you start soldering, protect any flammable material with a fireproof shield or wet rags, and have a fire extinguisher nearby.
- If possible, use a soldering iron stand or clamps when you are soldering, leaving one hand free to hold the solder.
- Never leave a soldering iron on unattended.

Reinforcing Picture Frames

If pictures are hung improperly, particularly heavy ones, the joints of the frame may pull apart. It's a good idea to reinforce joints before hanging to prevent future problems.

One way to reinforce frames is by using a metal frame-mending plate, which you can buy at hardware stores. Drill holes first before securing the plate with screws, making sure that the screws aren't so long that they come through to the front of the frame.

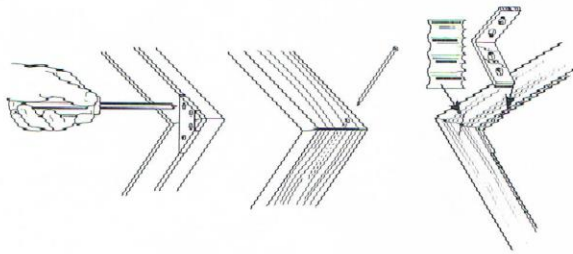

To reinforce a small frame, use a finishing nail. Drill a hole for the nail (a *pilot hole*) and then drive the nail through the joint. Countersink the nail head and fill with surfacing compound. Or, heat a crayon that is close in color to the wood and apply it over the nail head; you can scrape off the excess crayon with a fingernail.

For a very large frame, use a 1/2-inch dowel rather than a finishing nail. Drill a hole that is a little bit deeper than the dowel (for the glue). Coat the dowel with glue, hammer it into the hole, and cut the end flush with the surface of the frame.

Corrugated or *chevron fasteners* are useful for strengthening miter joints in a picture frame. Seal the edges with wood glue, and then hammer the sharp end gently across the joint. A small *angle iron* may also strengthen the joint.

Mending Pottery, Glass, and China

You can mend items made of pottery, glass, or china with quick-drying cements specially made for these materials. Each piece must be clean and dry.

Fit the pieces together like a puzzle *before* cementing so that you know where each belongs and in what order they should be placed together. Apply cement according to the package directions, holding pieces together with rubber bands or masking tape for the entire drying period. Or, you can easily make a *positioning box* by filling a shallow box three-quarters full with uncooked rice or beans. When you place the item in the box, it will stay upright and balanced while the glue sets.

Let the glue set for 24 hours. If the item is in several pieces, you may want to do **only a portion** at a time, letting each set thoroughly before continuing to glue.

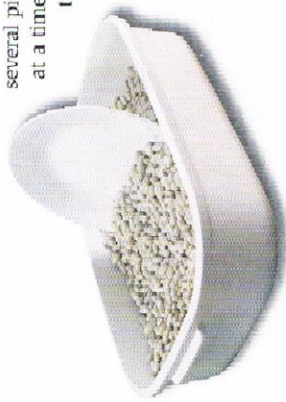

Soldering

Solder is a mixture of tin and lead (usually 60 percent tin and 40 percent lead) used to join together wires or other metals such as tin, copper, brass, or iron. Soldering is used in some plumbing jobs and can be used for minor repairs of kitchen items such as reattaching a handle to a collander.

Ribbon or wire solder with a rosin core is the most common type of solder. The rosin core in the center of this solder eliminates the need for a separate application of *flux*, which is a paste that removes tarnish from metal and helps make soldered joints stronger.

A 25- to 50-watt soldering pen is a good tool for the kinds of fine wires found in small appliances; soldering guns or irons with higher wattage are useful for larger soldering projects. Using the soldering gun for repairs is easy:

Step 1—Lightly scrape wires and metals to be soldered so that they are clean.

Step 2—Paint the area to be soldered with flux. Flux varies depending on the metal to be soldered. Make sure you use the right one. Acid fluxes corrode copper wires and must be washed away after soldering.

Step 3—Heat the soldering tool and apply it to the solder point. Feed the solder to the area from the top, letting it melt down over the joint.

Keep your soldering tool *tinned*, or coated with solder, at all times, to improve heat transfer and keep the tip of the tool in good working condition.

Repairing Furniture

You will find many products for filling holes

in wood: wood dough, wood filler, water putty, and stick shellac, for instance. Read the label to find out which will work best for the kind of hole you are filling.

Wobbly legs, loose rungs, splits, or warps detract from the appearance of wood furniture—and in time can lead to its ruin. Most of the time, minor repairs can solve the problem, and the piece will be as good as new.

Uneven Chair Legs

Place the chair on an even surface and note the airspace under the short leg. Even out this space by attaching a small metal glider to the shorter leg, or tack a small chip of wood to it. Remove the tack and wood-glue the chip in place. Before leaving the chair to dry, place a piece of foil or waxed paper under the leg in case of excess glue.

Filling Holes in Wood

If you are using wood dough or putty to fill a cavity, apply it so that it is slightly higher than the furniture surface. Let the filler dry thoroughly. It may shrink as it dries, so you may have to add another layer. Once it is dry and hard, sand the surface smooth, and then paint or stain and varnish the patch to match the surrounding color.

Repairing a Split in Wood

Fill splits with wood glue and then clamp with a vise, strong wire, or masking tape until dry. Protect the wood surface from scratches by padding the area with cardboard.

Basics of Sanding

Always sand with the grain of the wood when you are sanding by hand. If you don't, you'll leave scratches. Sand with an even pressure. For easier sanding, make a sanding block out of a block of wood that measures 3 or 6 x 3/4 x 1 inches. Pad the top and the bottom with cork or felt to protect the work. Wrap sandpaper around the block and hold it against the sides as you work.

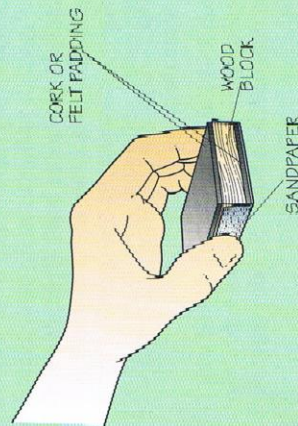

Loose Rungs

Remove the loose rung from its hole. Using sandpaper, steel wool, or a round file, clean the old glue out of the hole and from the iron (the protruding piece of wood that fits into the hole). Coat the iron with wood glue and wrap it with enough fine, strong thread so that it will fit tightly in the hole. Apply more glue to the thread and reinsert the rung into the hole. Clamp the joint until the glue dries.

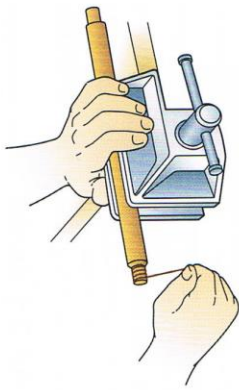

Loose Joints

Simply tightening joint screws often solves the problem of loose joints. Sometimes, however, you may need to add filler first in order to tighten a screw sufficiently.

You also can strengthen a chair with an angle iron, or a strategically placed wood block glued and nailed to the chair back. Be sure the nail doesn't puncture the finished surface.

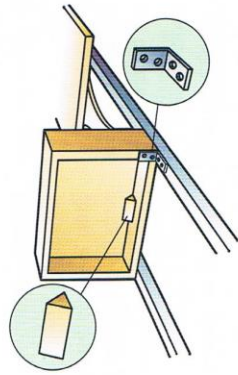

Water Rings and Fine Scratches

You can usually remove a water ring on wood furniture by rubbing it with toothpaste or another gentle abrasive cleaner. Buffing with very fine steel wool and furniture oil may remove surface scratches. When you are finished, clean the area thoroughly with a soft, dry cloth.

Veneer Bubbles and Dents

Veneer is a very thin layer of fine hardwood that is glued over a plywood or solid wood base. Sometimes the veneer bubbles up or dents down. A hot iron and a washcloth may be all you need to restore the surface, as you will soften the glue and then allow it to reharden. Use a dry iron and dry cloth on a bubble, and a steam iron and damp cloth on a dent. In both cases, be careful not to hold the iron down too long—just 5- or 10-second cycles, checking for scorching—so that you don't damage the finish. Cover the heated area with waxed paper and weight it down until the glue rehardens.

Painting, Staining, and Varnishing Wood

Restoring a piece of furniture to like-new condition, or repainting a major piece of house trim, such as a door, can give you a lot of satisfaction. When painting, choose enamel for woodwork because it's easier to keep clean. Enamel comes in latex or alkyd-based paint with either a high gloss or satin finish. For durability, buy the best paint you can afford.

Preparation

Painting and staining projects begin with similar preparation. Both also require careful attention to detail for the best results.

- Step 1**—Remove any hardware and clean the surface of all dirt and grime with household cleaner.
- Step 2**—Strip the old finish, if necessary. Use a commercial stripper and follow the manufacturer's directions. Read the label.
- Step 3**—Fill cracks and make any needed repairs.
- Step 4**—Lightly sand the entire object. Clean it with a soft, dry cloth to remove all the dust caused by sanding.

Painting and Varnishing

Step 1—Stir the paint thoroughly. If the paint has been used already, you may need to strain out any impurities with cheesecloth or an old nylon stocking.

Step 2—Lay down the first coat of enamel with long, full strokes. Smooth out runs before they set.

Step 3—When the surface is covered, go over the coat crosswise with the tip of the brush to smooth out the brush strokes.

Step 4—Allow the paint to dry thoroughly. Drying time depends on temperature and humidity.

Step 5—Resand with steel wool and wipe the piece of furniture clean. Apply a second coat in the same manner.

Spray Painting

Spray small objects in a cardboard box to contain excess spray. Spray larger objects outside or in a garage or basement. Protect floors and walls with a large spread of newspapers or drop cloths.

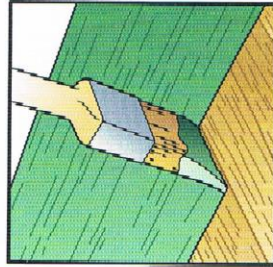

Make the first coat of spray paint very light and barely noticeable. The second coat can be a bit heavier. Let the paint dry thoroughly between coats.

Staining

Staining changes the color of wood and enhances the natural wood grain. There are two basic types of stains: *penetrating* and *pigmented*. Each has its advantages and disadvantages. *Gel stains* combine some of the best qualities of both stain types and are easy to apply.

Here are some hints for successful staining:

- End grains soak up stain more than the rest of the wood, so seal ends with shellac before staining. After drying, sand off any shellac that has lapped onto other areas.
- Apply stain with a chisel-end brush, foam pad, or lint-free cotton cloth (such as cheesecloth).
- Wipe off excess stain with a clean cloth.
- A second coat will darken the stain.

You can finish a stained piece with a polyurethane or varnish coating. Polyurethane is clear; varnish has some tint and may affect the stain color. Apply varnish with the wood grain. Smooth out runs before they set. Sand the piece with steel wool and wipe off the dust between coats.

Care and Storage of Equipment

Clean your brushes after each use. Cleaning takes only a few minutes and will help brushes last a long time. Allowing paint to harden in a brush makes cleaning difficult and time-consuming. If the same brush and paint have been used over several days, store the brush overnight (with most of the paint wiped off) in tightly folded aluminum foil or wet paper.

Clean brushes that have been used in oil-based paint with a solvent-based cleaner such as mineral spirits. (Follow the solvent cleaning by washing in warm sudsy water and rinsing.) With water-based paint, clean the equipment with soap and water, then rinse. Carefully smooth down the bristles and wrap the brush in its original packaging or heavy paper.

Remove roller covers from the frame. Clean them with the appropriate solvent or soap and water; rinse well. Clean up around the painted area. After the paint has dried on the drop cloth, shake off any debris, then fold or roll it up neatly. Sweep up any debris and properly dispose of it.



The most important part of taking care of any paint application tool or equipment is cleaning it immediately after painting. Failure to do so can cost you more time and more money spent on special cleaners, which in some cases may ruin the tool.

Doors and More

Making the outside of your home sound, safe, and attractive is just as important as keeping up the inside.

Safety First

Get help from another person when lifting a heavy door or gate off its hinges during a repair job.



Repairing Sagging Doors and Gates

A loose hinge is often responsible for a sagging door. If that's the problem in your home, brace the door with a wedge and tighten the screws. If the holes are too large and have been stripped, fill the cavity with wood plugs—a wooden golf tee dipped in wood glue works well. Drive it into the hole with a hammer as far as it will go.

After the glue dries, cut the tee or plug off so that it is level with the surface of the hinge. Then you can reset the screw into the new material. This method works just as well with outside gates. If tightening the screws isn't sufficient, add extra nails.

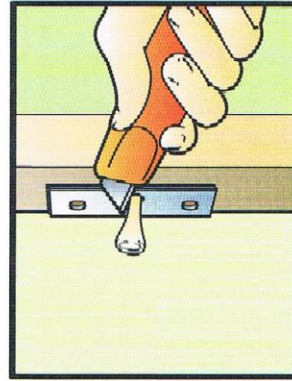
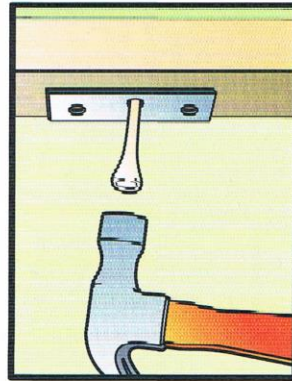

Sometimes the weight of a gate makes it sag. Installing a *sag rod* (also called a *tension support*) or *wire-and-turnbuckle* arrangement will correct this problem. Support the gate in the proper position with a piece of wood before attaching the hardware. To attach the wire, rod, or cable, use bolts or install eye hooks at the top of the hinged side and the bottom of the opposite side. Tighten the turnbuckle to adjust the tension on the cable and pull the gate into position. The sag rod needs to be installed on the hinge side of the gate. (You can also use a wire-and-turnbuckle to help with a sagging door.)

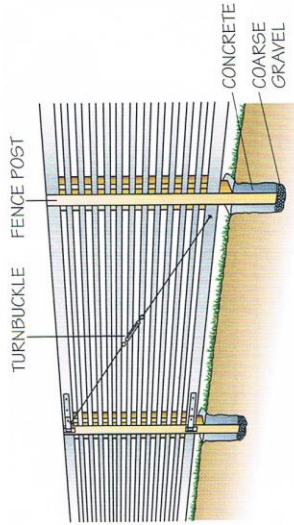

Repairing Stairs

A loose step is dangerous, and often all it takes to fix it is a well-placed nail. If the step is rotted or split, however, you must replace it. Cut a new one of the same length and nail it to the cleat. If the cleat is rotten or broken, replace it first. Bolt cleats to the side of the stair, called the *stringer*.

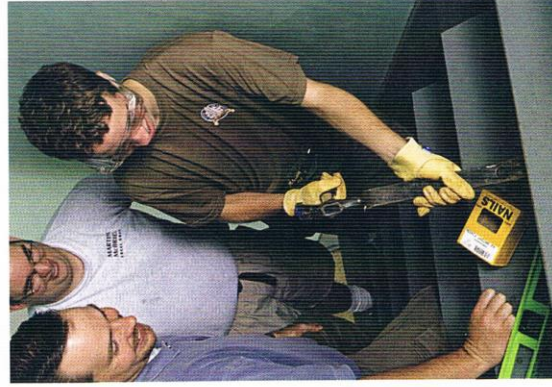
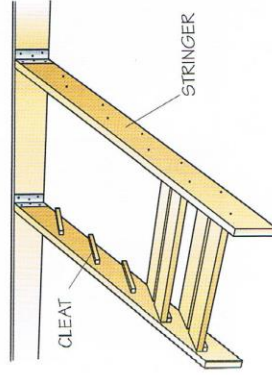

Repairing Railings

Loose railings are a serious hazard, but before repairs begin you must figure out the root of the wobble. If the rail is pulling away from the newel post, follow the steps below. If the newel posts are loose, it is best to consult a professional.

Step 1—Drill a pilot hole at an angle through the newel post into the loose handrail. (See views 1a and 1b.)

Step 2—Work wood glue into the joint between the post and railing.

Step 3—Countersink a wood screw into the pilot hole and tighten.

Another option is to work from the opposite direction. Drill pilot holes at an angle through the sides of the railing into the newel post, apply wood glue to the joint, then nail the railing firmly to the post. (See view 4.)

If the whole railing is loose, reinforce it by attaching blocks to fit snugly between each pair of posts, then glue and nail them into place. (See views 5 and 6.) For a more polished look, you will want to paint the block.

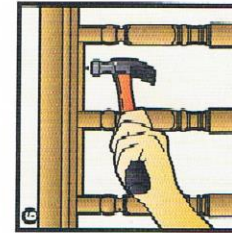
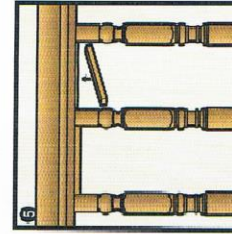
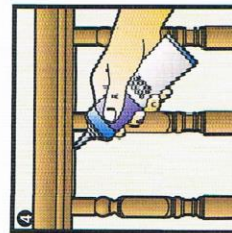
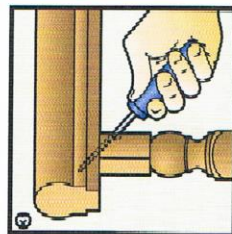
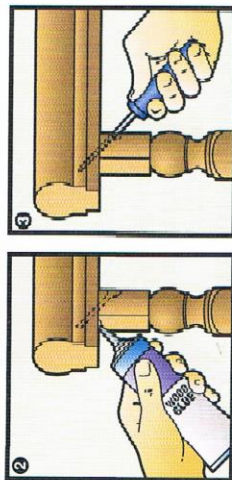
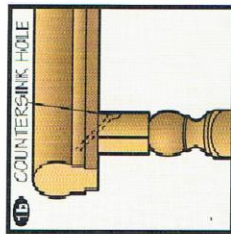
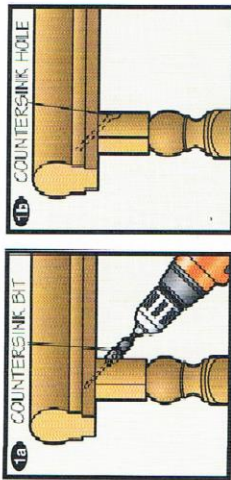

Repairing Fences

People in different parts of the country prefer different kinds of fences. Among the most common types are picket, board, rail, and chain-link fences. Each has its own advantages. Construction and repair of these fences are also unique, although there are some common procedures.

Fence posts usually are set in large holes with concrete. Several handfuls of coarse gravel at the bottom of the hole promote drainage and deter wood rot.

The *fence rails* usually are horizontal pieces of wood or metal to which the *infill* is attached. The infill can be any one of several varieties of pickets, boards, or metal fencing placed perpendicularly to the rails and/or posts.

Renailing pickets or boards is a common fence repair.

Another is replacing an entire picket or board if it is damaged. If you have a loose fence post, you can bolster it with a fence iron. Butt the fence iron next to the post, placing the side of the fence iron that has nail holes against the post. Hammer the iron into the ground and then attach the iron to the post with nails.

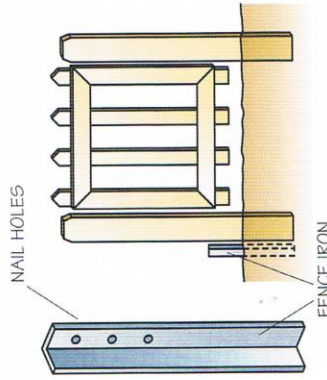

Sag rods (also known as tension supports) are optional for the wood gates described here, but they are easy to install and add stability to the gate posts. They are rods or cables with bolts to secure them to the posts. They should be installed near the top of the gate post and run down to nearly the bottom of the closest fence post in the same section. Use the turnbuckles in the rod to adjust the rod or cable tension to keep the gate post steady. The sag rod need only be installed on the hinge side of the gate. Sag rods can be bought in most hardware stores and building supply stores.

Home Repairs Resources

Scouting Literature

Electricity, Electronics, Fire Safety, Painting, Plumbing, Welding, and Woodwork merit badge pamphlets

Visit the Boy Scouts of America's official retail website at <http://www.scoutstuff.org> for a complete listing of all merit badge pamphlets and other Scouting resources.

Books

Better Homes and Gardens editors. *New Complete Guide to Home Repairs and Improvement*. Better Homes and Gardens Books, 2001.

Black and Decker Home Improvement Library. *The Complete Guide to Home Repair*. Creative Publishing International, 2004.

_____. *Refinishing and Finishing Wood*. Creative Publishing International, 1994.

Erickson, Larry, editor. *Ortha's Home Improvement Encyclopedia*. Meredith Books, 2000.

Frank Cawood & Associates, eds. *Fix It, Clear It and Make It Last*. Frank Cawood & Associates Publishing, 2000.

Gladstone, Bernard. *The Simon & Schuster Complete Guide to Home Repair and Maintenance*. Simon & Schuster, 1991.

Hamilton, Gene, and Katie Hamilton. *Rodale's Fix It Fast, Fix It Right*. MJF Books, 1997.

Jackson, Albert, and David Day. *Popular Mechanics Complete Home How-To*. Hearst, 2004.

Manfredini, Lou, with Curtis Rist. *Mr. Fix-It Introduces You to Your Home*. Ballantine Books, 2002.

McClintock, Mike. *Home Book: The Ultimate Guide to Repairs and Improvements*. Creative Homeowner Press, 2000.

Nagyszalanczy, Sandor. *The Homeowner's Ultimate Tool Guide*. Taunton, 2003.

Popular Mechanics editors. *Home How-To: Easy-to-Follow Step-by-Step Instructions With More Than 3,000 Color Illustrations and Photographs*. William Morrow & Co., 2000.

Reader's Digest editors. *New Fix-It-Yourself Manual*. Reader's Digest Association Inc., 1996.

Sunset Home Repair Handbook. Sunset Publishing Co., 1999.

Time-Life Books. *Time-Life Books Complete Fix-It-Yourself Manual*. Prentice-Hall, 1989.

_____. *How Things Work in Your Home (and What to Do When They Don't)*. Henry Holt, 1987.

Wing, Charles. *The Book of Small Household Repairs*. Reader's Digest, 1999.

Organizations and Websites

Ask the Builder

Website: <http://www.askthebuilder.com>

CornerHardware.com

12815 N. Cave Creek Road
Phoenix, AZ 85022
Toll-free telephone: 877-825-1497
Website: <http://www.cornerhardware.com>

Creative Homeowner

24 Park Way
P.O. Box 38
Upper Saddle River, NJ 07458
Toll-free telephone: 800-631-7795
Website: <http://www.chp-publisher.com>

Environmental Protection Agency

1200 Pennsylvania Ave. NW
Washington, DC 20460
Telephone: 202-272-0167
Websites: <http://www.epa.gov/iedweb00/asbestos.html>
<http://www.epa.gov/opptintr/lead/>

National Fire Protection Association

1 Batterymarch Park
Quincy, MA 02169-7471
Telephone: 617-770-3000
Website: <http://www.nfpa.org>

This Old House Online

1185 Avenue of the Americas, 27th floor
New York, NY 10036
Telephone: 212-522-9465
Website:
<http://www.thisoldhouse.com/toh/>

Toiletology 101

Website: <http://www.toiletology.com>

Underwriters Laboratories Inc.

333 Pfingsten Road
Northbrook, IL 60062-2096
Telephone: 847-272-8800
Website: <http://www.ul.com>

Acknowledgments

The Boy Scouts of America is grateful to Creative Homeowner Press and Al Carrell, author of the nationally syndicated column "The Super Handyman," for permitting the use of copyrighted material and additional materials for the original merit badge pamphlet. Thanks also to William and Liz Augustine of the American Association of Home Repair Clubs for their assistance in the revision of this pamphlet.

The Boy Scouts of America is grateful to the men and women serving on the Merit Badge Maintenance Task Force for the improvements made in updating this pamphlet.

Photo and Illustration Credits

©Jupiterimages.com—cover (all except merit badge, tool box, ladder); pages 64 and 73

All other photos and illustrations not mentioned above are the property of or are protected by the Boy Scouts of America.

Dan Bryant—pages 42 (hand tools) and 43

Daniel Giles—pages 6, 20, 25, 28, 35, 38, 58, 60 (top), 66, 68 (bottom), 69, and 75

Joan McDearmon—all illustrations on pages 12–19, 23, 26–27, 31–34, 37, 39, 42, 57, 59–61, 65, 68, 70–72, and 74–77

Randy Pland—pages 45 (both)

Permission to use the UL name and trademark has been granted by Underwriters Laboratories Inc.

MERIT BADGE LIBRARY

Though intended as an aid to Boy Scouts, Varsity Scouts, and qualified Venturers and Sea Scouts in meeting merit badge requirements, these pamphlets are of general interest and are made available by many schools and public libraries. The latest revision date of each pamphlet might not correspond with the copyright date shown below, because this list is corrected only once a year, in January. Any number of merit badge pamphlets may be revised throughout the year; others are simply reprinted until a revision becomes necessary.

If a Scout has already started working on a merit badge when a new edition for that pamphlet is introduced, he may continue to use the same merit badge pamphlet to earn the badge and fulfill the requirements therein. In other words, the Scout need not start over again with the new pamphlet and possibly revised requirements.

Merit Badge Pamphlet	Year	Merit Badge Pamphlet	Year	Merit Badge Pamphlet	Year
American Business	2002	Environmental Science	2005	Plant Science	2005
American Cultures	2005	Family Life	2008	Planting	2004
American Heritage	2005	Farm Mechanics	2008	Pottery	2008
American Labor	2006	Fingerprinting	2003	Public Health	2013
Animal Science	2006	Fire Safety	2004	Public Speaking	2003
Archaeology	2006	First Aid	2007	Pulp and Paper	2008
Archeology	2004	Fish and Wildlife Management	2004	Radio	2006
Architecture and Landscape Architecture	2010	Fishing	2009	Railroading	2003
Art	2006	Fly-Fishing	2009	Reading	2003
Astronomy	2013	Forestry	2005	Reptile and Amphibian Study	2005
Athletics	2006	Gardening	2013	Rifle Shooting	2001
Automotive Maintenance	2012	Genealogy	2003	Robotics	2011
Aviation	2006	Geocaching	2010	Rowing	2006
Backpacking	2007	Geology	2005	Safety	2006
Basketry	2003	Golf	2002	Salesmanship	2003
Bird Study	2005	Graphic Arts	2006	Scholarship	2004
Bugling (see Music)	2005	Hiking	2007	Scouting Heritage	2010
Camping	2005	Home Repairs	2009	Scuba Diving	2009
Canoeing	2004	Horsemanship	2010	Sculpture	2007
Chemistry	2004	Indian Lore	2008	Search and Rescue	2012
Chess	2011	Insect Study	2008	Shotgun Shooting	2005
Cinematography	2008	Inventing	2010	Skating	2005
Citizenship in the Community	2005	Journalism	2006	Small-Boat Sailing	2004
Citizenship in the Nation	2005	Kayaking	2012	Snow Sports	2007
Citizenship in the World	2005	Landscape Architecture (see Architecture)		Soil and Water Conservation	2004
Climbing	2011	Law	2003	Space Exploration	2004
Coin Collecting	2008	Leatherwork	2002	Sports	2006
Collections	2008	Lifesaving	2008	Stamp Collecting	2007
Communication	2009	Mammal Study	2003	Surveying	2004
Composite Materials	2006	Medicine	2009	Swimming	2008
Computers	2009	Metalwork	2007	Textile	2003
Cooking	2007	Model Design and Building	2010	Theater	2005
Crime Prevention	2005	Motorboating	2008	Traffic Safety	2006
Cycling	2003	Music and Bugling	2003	Truck Transportation	2005
Dentistry	2006	Nature	2010	Veterinary Medicine	2005
Disabilities Awareness	2005	Nuclear Science	2010	Water Sports	2007
Dog Care	2012	Oceanography	2009	Weather	2006
Drafting	2008	Orienteering	2003	Welding	2012
Electricity	2004	Painting	2008	Whitewater	2005
Electronics	2004	Personal Fitness	2006	Wilderness Survival	2007
Emergency Preparedness	2012	Personal Management	2003	Wood Carving	2006
Energy	2005	Pets	2003	Woodwork	2011
Engineering	2008	Photography	2013		
Entrepreneurship	2006	Pioneering	2006		

BOY SCOUTS OF AMERICA • SUPPLY GROUP

NATIONAL DISTRIBUTION CENTER
2109 Westinghouse Boulevard
P.O. Box 7143
Charlotte, NC 28241-7143
www.scoutstuff.org

DIRECT MAIL CENTER
P.O. Box 909
Pineville, NC 28134-0909
For fast credit card orders —
VISA, MasterCard, American Express —
call BSA operators toll-free
1-800-323-0732