

HOW TO USE THIS PAMPHLET

The secret to successfully earning a merit badge is for you to use both the pamphlet and the suggestions of your counselor.

Your counselor can be as important to you as a coach is to an athlete. Use all of the resources your counselor can make available to you. This may be the best chance you will have to learn about this particular subject. Make it count.

If you or your counselor feels that any information in this pamphlet is incorrect, please let us know. Please state your source of information.

Merit badge pamphlets are reprinted annually and requirements updated regularly. Your suggestions for improvement are welcome.

Send comments along with a brief statement about yourself to Youth Development, S209 • Boy Scouts of America • 1325 West Walnut Hill Lane • P.O. Box 152079 • Irving, TX 75015-2079.

WHO PAYS FOR THIS PAMPHLET?

This merit badge pamphlet is one in a series of more than 100 covering all kinds of hobby and career subjects. It is made available for you to buy as a service of the national and local councils, Boy Scouts of America. The costs of the development, writing, and editing of the merit badge pamphlets are paid for by the Boy Scouts of America in order to bring you the best book at a reasonable price.



BOY SCOUTS OF AMERICA
MERIT BADGE SERIES

MODEL DESIGN AND BUILDING



BOY SCOUTS OF AMERICA®

Requirements

1. Study and understand the requirements for personal safety when using such modelmaker hand tools as knives, hand-saws, vises, files, hammers, screwdrivers, hand drills and drill bits, pliers, and portable power tools, and when to use proper protective equipment such as goggles when grinding or drilling. Know what precautions to take when using flammable or hazardous products such as glue, epoxy, paint, and thinners. Discuss these with your counselor before you begin your modelmaking project and tell why they are important.
2. Explain the uses for each of the following types of models: architectural, structural, process, mechanical, and industrial. Do research into the different types of materials that could be used in making these models.
3. With your counselor's advice, select a subject from requirement 4 for your model project (no kits). Prepare the necessary plans to the proper scale. Make a list of materials and a list of the required tools. This model should be your own original work. Tell your counselor why you selected this subject.

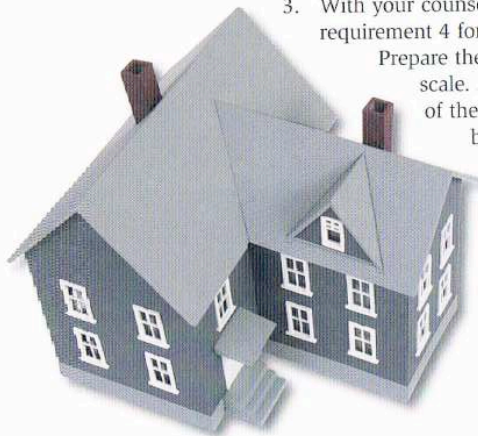

35919
ISBN 978-0-8395-3280-4
©2010 Boy Scouts of America
2011 Printing

BANG/Brainerd, MN
5-2011/062026

4. Do ONE of the following:
 - a. Make an architectural model. Build a model of a house to a scale of $\frac{1}{4}$ " = 1'0" (50:1 metric). Discuss with your counselor the materials you intend to use, the amount of detail required, outside treatment (finish, shrubbery, walks, etc.), and color selections. After completing the model, present it to your counselor for approval.
 - b. Build a structural model. Construct a model showing corner construction of a wood-frame building to a scale of $1\frac{1}{2}$ " = 1'0" (8:1 metric). All structures shown must be to scale. Cardboard or flat sheet wood stock may be used for sheathing or flooring on the model. Review with your counselor the problems you encountered in gathering the materials and supporting the structure. Be able to name the parts of the floor and wall frames, such as intermediate girder, joist, bridging, subfloor, sill, sole plate, stud, and rafter.
 - c. Make a process model. Build a model showing the plumbing system in your house. Show hot and cold water supply, all waste returns, and venting to a scale of $\frac{3}{4}$ " = 1'0" (15:1 metric). Talk to your counselor about how to begin this model, and present the scale and the materials you will use. After completion, present the model to your counselor, and be prepared to discuss any problems you had building this model.
 - d. Complete a mechanical model. Build a model of a mechanical device that uses at least two of the six simple machines. After completing the model, present it to your counselor. Be prepared to discuss materials used, the machine's function, and any particular difficulty you might have encountered.
 - e. Make an industrial model. Build a model of an actual passenger-carrying vehicle to a scale of 1" = 1'0" or $\frac{1}{2}$ " = 1'0" (10:1 or 25:1 metric). Take the dimensions of the vehicle and record the important dimensions. Draw the top, front, rear, and sides of the vehicle to scale. From your plans, build a model of the vehicle and finish it in a craftsmanlike manner. Discuss with your counselor the most difficult part of completing the model.

5. Build a special-effects model of a fantasy spacecraft that might appear in a Hollywood science-fiction movie. Determine an appropriate scale for your design—one that makes practical sense. Include a cockpit or control area, living space, storage unit, engineering spaces, and propulsion systems. As you plan and build your model, do the following:
 - a. Study aircraft, submarines, and naval ships for design ideas.
 - b. Arrange and assemble the parts.
 - c. Sketch your completed model.
 - d. Write a short essay in which you discuss your design, scale, and materials choices. Describe how you engineered your model and discuss any difficulties you encountered and what you learned.
6. Find out about three career opportunities in modelmaking. Pick one and find out the education, training, and experience required for this profession. Discuss this with your counselor, and explain why this profession might interest you.

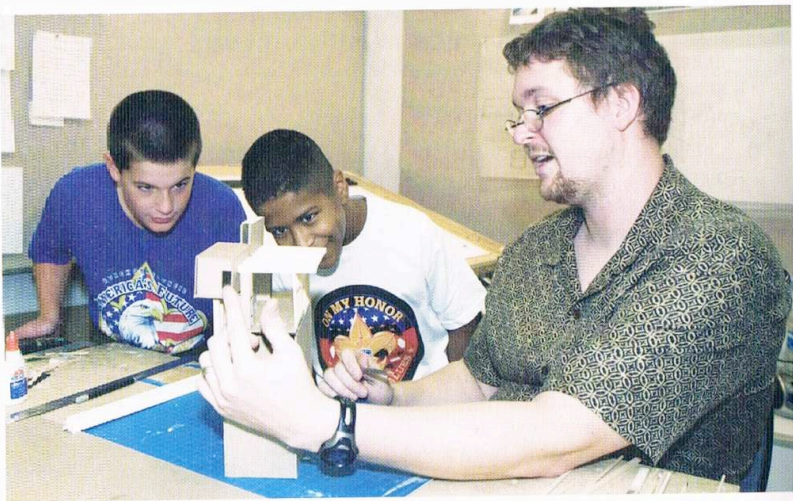

Contents

The Art of Modelmaking	7
Safe Use and Care of Hand Tools	11
Scale	18
Materials and Finishes	25
Architectural Models	29
Structural Models	35
Process Models	41
Mechanical Models	46
Industrial Models	53
Mission: Fantasy Spacecraft	57
Modelmaking As a Career	60
Model Design and Building Resources	63



The Art of Modelmaking

A movie theater rumbles as a star destroyer glides across the screen. An architect unveils his vision for a new downtown skyscraper. A sports car slices effortlessly through the wind as it zips along a mountain road. A child wades through a replica of the Mississippi River, traveling a "mile" every few steps. A train enthusiast puts the finishing touches on an elaborate basement layout. A Boy Scout creates a futuristic samurai warrior using parts from several Japanese *mecha* kits.

What unites these scenes is modelmaking, the art of creating copies of objects that are either smaller or larger than the objects they represent. Sometimes the model comes first, as with architectural models. Sometimes the model copies something that already exists, such as that replica of the Mississippi River. Sometimes the model comes first and last. For example, car designers build small models first, then factories turn out full-scale versions, and then toy companies build small-scale replicas for kids to play with.

Mecha is a term from Japanese animation that refers to giant robots and other fantastic mechanical objects. Mecha model kits are popular in Japan.

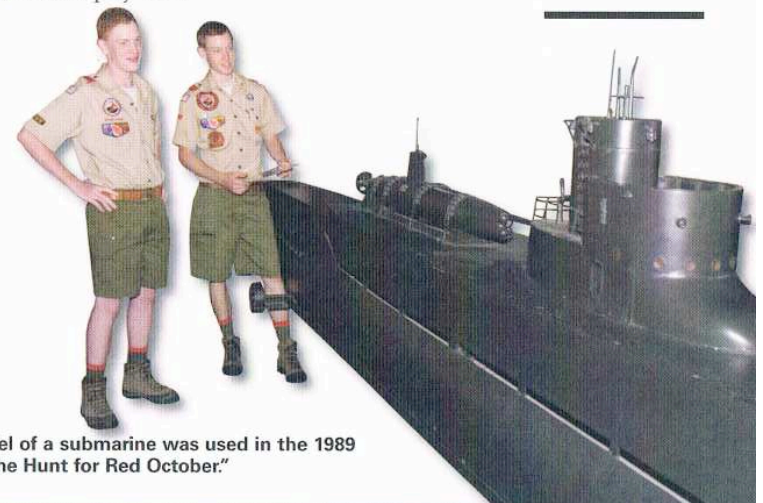

This model of a submarine was used in the 1989 movie "The Hunt for Red October."

A lot of people think that modelmaking is just a fun hobby—and it certainly is fun to build a samurai warrior or a model-train layout. But models can have serious purposes, too. As you work on this merit badge, you will get to experience both the fun and the serious sides of modelmaking and learn how modelmaking can be both a hobby and a career.



Types of Models

People make and use models for all sorts of reasons. Architects build models to help others understand what new structures will look like. Car designers put models in wind tunnels to test their *aerodynamics*, or wind resistance. Teachers use models to help students understand very big things (like the Mississippi River) or very small things (like molecules). Filmmakers use models—either “real” ones or those that exist only in a computer—to create scenes that would otherwise be impossible to film, like star destroyers gliding through space. Those are just some ways people use models.

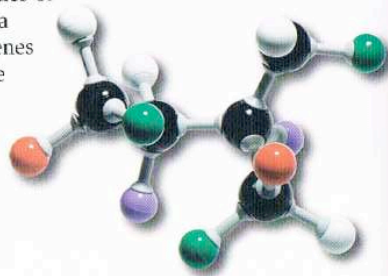

For example, civil engineers use models in designing dams and flood-control structures, while mechanical engineers use them to determine the placement of pipes and ventilation equipment in buildings. Furniture designers use models to help make chairs more comfortable and tables more attractive, while police detectives use them to replicate crime scenes. Other uses for professional-quality models are listed in the section of this pamphlet that discusses modelmaking as a career.

Requirement 4 asks you to build one of the following types of models that are used in business and industry.

- **Architectural**—a model of a house
- **Structural**—a model showing corner construction of a wood-frame building
- **Process**—a model of the plumbing system in a house
- **Mechanical**—a model of a mechanism that does some kind of work
- **Industrial**—a model of a passenger-carrying vehicle

Before choosing which type of model to build, be sure to get your counselor’s advice. Although only one model is required for this merit badge, you may want to build more than one.

Filmmakers today rely on computer-generated imagery—CGI—to create many special effects, but they still use physical models (or *miniatures*).

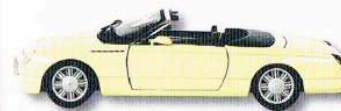



Safe Use and Care of Hand Tools

Depending on the models you make for this merit badge, you will need to use a variety of hand tools. By using your tools safely, you will avoid accidents, reduce injuries, prevent damage to the tools, and build better models. By caring for your tools correctly, you will ensure their usefulness for many years to come.

If you have earned a Totin' Chip for knife and ax safety, you already know how important safety is. The Totin' Chip is like a driver's license for carving and shows that you understand how to use woods tools safely. If you don't have a Totin' Chip pocket certificate yet, ask your Scoutmaster how you can earn one. You will need it to participate in many Scout activities, so carry it with you at all times.

Use power tools only under the close supervision of a responsible adult.

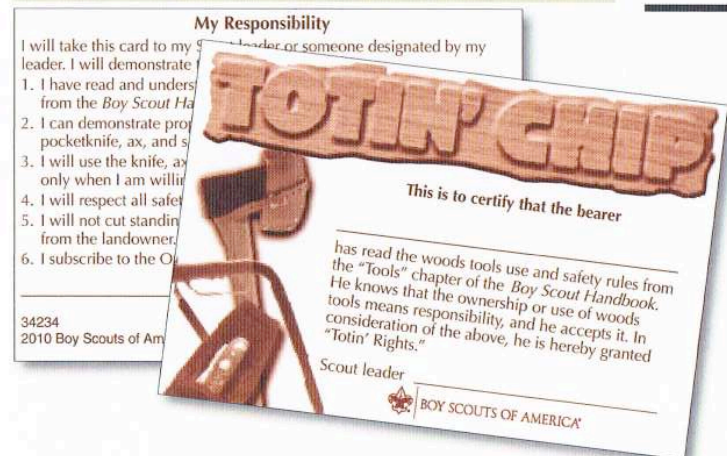

General Tips

There are many dos and don'ts to keep in mind when using tools.

- Never work alone when using power tools.
- Use each tool for what it was made to do—never for anything else. For example, use a screwdriver only for driving screws, not as a chisel or a pry bar.
- Inspect your tools and use only tools that are in good working condition. Broken tools could hurt you or damage your model.
- Get out only the tools you need and return them to your toolbox as soon as you are finished. This will keep your work area neat and prevent damage to the tools.
- Take good care of your tools. Keep them clean, oiled, and sharp.

Face and Hand Protection

Using the proper equipment will prevent most accidents, but be prepared for the unexpected. Whenever appropriate, wear gloves and a face shield or goggles. Make sure the face shield headband fits properly (follow the manufacturer's instructions on proper fit), and be sure to clean or wipe the goggles after use.

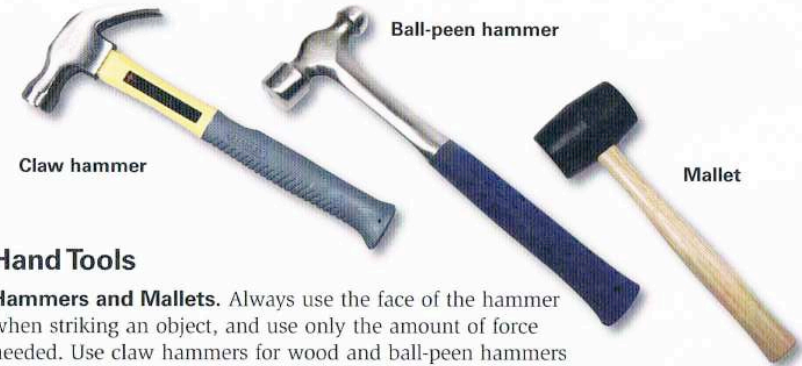
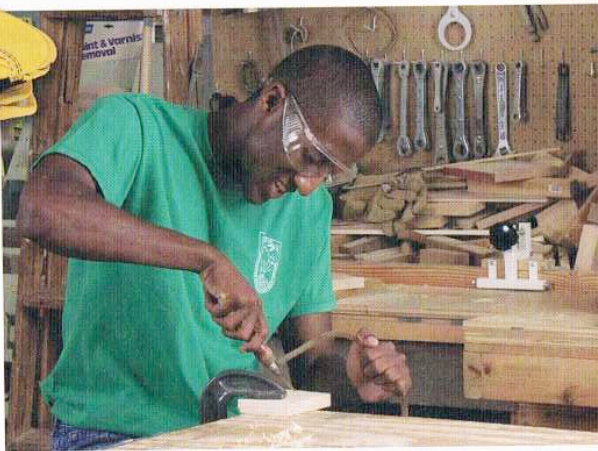

Claw hammer

Ball-peen hammer

Mallet

Hand Tools

Hammers and Mallets. Always use the face of the hammer when striking an object, and use only the amount of force needed. Use claw hammers for wood and ball-peen hammers for metal. Only use a hammer's claw for removing nails.

Handsaws. Use a vise to secure the material being sawed. To prevent buckling or breaking, adjust the blade tension and make sure blades are installed firmly in the correct position. While working, provide enough clearance so that, as you saw, the point of the saw will not strike any object. Use steady, even strokes without bending the blade. Saws cut on a forward stroke, so apply more pressure on that stroke. When you are finished sawing, carefully wipe the blade clean and store the saw safely in a tool rack. Make sure other tools are not on top of the blade.

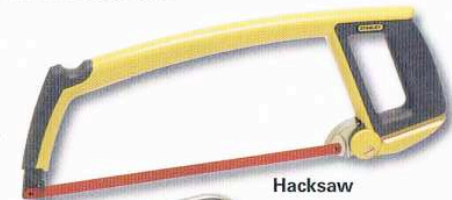

Hacksaw



Coping saw

Screwdrivers. Choose the correct blade size when using a screwdriver. Keep the handle directly over the screw head and turn with smooth, even strokes while applying steady pressure on the screw.

Flathead (slotted) screwdriver



Phillips screwdriver



Use vises and clamps to help keep your project in place while you work.

Clamps (C-Clamps, Bar Clamps). Use the proper size clamp, and do not overtighten the clamp. Otherwise, you could damage your materials or work surface. Always keep clamps clear of saws and drilling equipment.



Bench vise

Bench Vises. Always attach the vise to a firm work stand and use the vise—never your hands—to secure materials. Use just enough pressure to securely hold materials. Stay clear of the vise body during drilling or cutting operations. When you are done, close the vise and leave the handle straight up and down.

Hand Files. Always use a file with a handle. Cut in the direction for which the file was intended, and keep hard objects from striking the file teeth or handle. After use, clean a file with a file card (a special tool with metal bristles) or a wire brush, and store files in a single layer (never on top of each other) in a dry place.



Hand files

Chisels and Gouges. Always wear safety goggles when carving, and select tools big enough for the job. Use a chisel or gouge on metal only if it is a “cold chisel” meant for metal, and use only wooden mallets to hammer on chisels and gouges. Before you begin, clamp the material securely in a bench vise. Chip toward the stationary jaw of the vise, using the blade, not the point or corner. When you are done, cover the blades and store your carving tools in a dry area.

Chisel

Gouge

Open-ended wrench



Adjustable wrench

Have a professional sharpen or regrind your tools as needed. Improper maintenance could permanently damage your tools.

Wrenches (Open-end, Adjustable, Socket). Use the correct size wrench. Pull the wrench toward you, not away from you. Tighten bolts so they are secure but not too tight. It is rarely necessary to use extension bars on wrenches when tightening or loosening bolts.

Pliers. Be sure your fingers or hands do not get pinched between the handles of pliers. When using cutting pliers, cover the piece you are cutting or point it away from you and other people. The cut piece may become airborne.

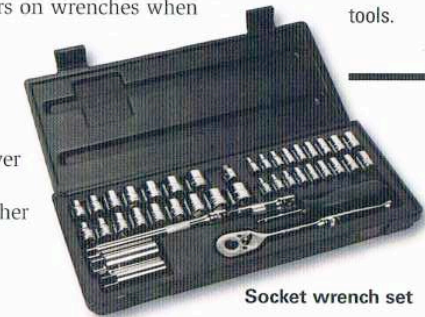

Socket wrench set



Pliers

Knives. Use sharp blades that do not have any nicks. Cut away from your body. When you are done, cover the blade and put the knife away.



A dull tool is a dangerous tool.

Scribers. Use a scriber to mark centerlines or cut lines on plastic material. Use the scriber only for its intended purpose, not as a center punch, pry, or pick. When carrying a scriber, hold it by the handle with the point away from you.

Hand Drills and Routers.

Use a vise or clamp to secure the material being drilled. Do not force a drill into the work, and never hit the handle with a hammer or mallet. Avoid taking heavy cuts through material, and run routers and drills at the correct speed for the material. Keep the bit away from any clamping device. As you work, use a brush to sweep away chips.



Drill Bits, Countersinks, and Router Bits.

Always use sharp bits. Tighten the shank of the drill bit securely in the chuck; never use pliers to tighten a bit. Cut only materials for which the router bits were designed.



Portable Power Tools

Before using any portable power tools, talk to your counselor and the owner of the tools about the safe and proper operation of the tools you plan to use. Here are some simple guidelines to remember:

- Use portable tools only for the work they are meant to do. Ask your counselor if you think you might need to use a more heavy-duty tool.
- When using a corded power tool, arrange the cord so that it will not be in the way of the operation.
- Carry a portable power tool by its handle, not its cord.
- When unplugging a power tool, grasp the plug head, not the cord, and pull straight out from the wall socket or extension cord.

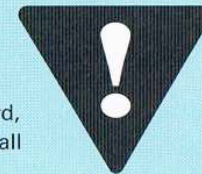

Use tools only under the close supervision of a responsible adult.

Scale

The word *gauge* is sometimes used in model railroading, where it refers to the distance between the rails in a train layout. Today, however, most model railroaders talk about scale, not gauge.

What does the word *scale* mean? The word has many definitions. You can weigh things on a scale. A fish has scales. You can do something on a grand scale, meaning larger or bigger than normal.

In engineering and modeling, *scale* has two main meanings. First, a modelmaker or machinist uses a ruler that is called a scale. Second, scale is used to describe *proportion*, or how the size of the model compares with the size of the actual object.

The relationship between the model and the original is expressed as a *ratio*, which uses two numbers to show how the size of one thing relates to the size of another. The first number represents the model's scale in multiples of the original's size, which is the second number.

If someone said to you, "I'm going to build a model of this telephone to double scale," that would mean the finished model would be twice as big as an average telephone. The model telephone would have a scale of 2:1, meaning two inches on the model would equal one inch on the original.

If someone said, "I'm going to build a one-third-scale model of this automobile," you would know the finished model would be only one-third as big as a real car. The model car would have a scale of 1:3. Of course, that would still be one big model!

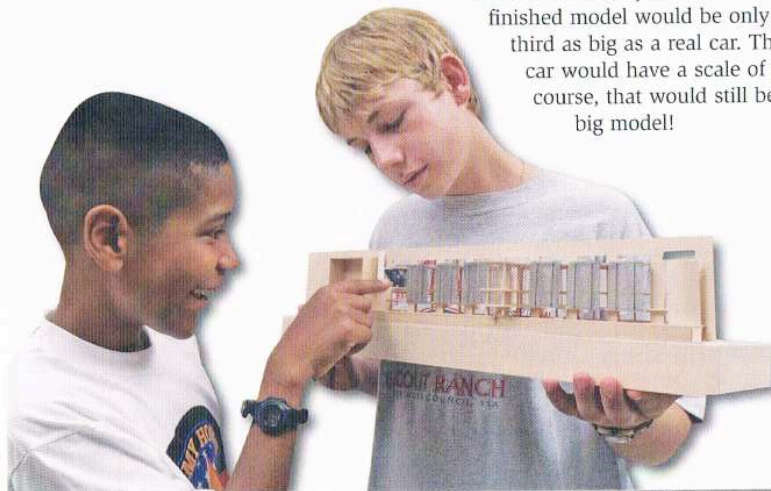

Some areas of modeling have standard scales. Model trains, for example, are typically HO scale (1:87) or N scale (1:160). Model airplanes usually have a scale of 1:72 or 1:144 (for airliners and other large aircraft), although other standard scales are sometimes used.

If you were building a hangar for a model stealth fighter, for example, you would want to be sure to use the same scale as the plane model. In other cases, you get to choose the scale. Typically, you choose the scale based on how big you want the model to be.

Measuring Systems

The two basic systems used for measurements are the *foot-and-inch* (or *imperial*) system, and the *metric system*, in which the meter is the basis of all length measurements. In this pamphlet, we will use the foot-and-inch system. When we talk about scale from now on, we will be talking about the proportions of models or plans as they relate to a one-foot, zero-inch ruler.

As a basis for model scales, the one-foot ruler has 12 equal parts, each of which is called an inch. The ruler can easily be divided:

- With two parts, each part equals 6 inches.
- With three parts, each equals 4 inches.
- With four parts, each equals 3 inches.
- With six parts, each equals 2 inches.
- With 12 parts, each equals 1 inch.

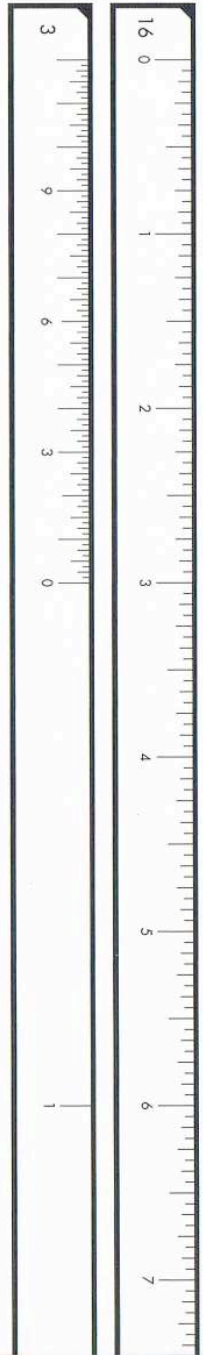
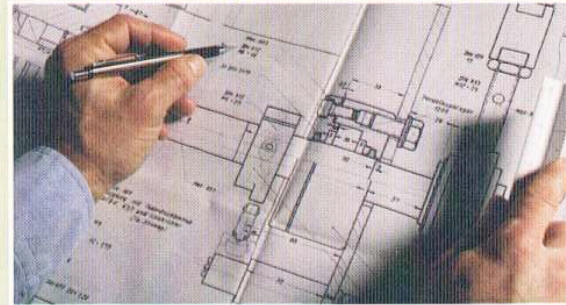

The 6-inch-long part is said to be one-half (1:2) scale or proportion. The 4-inch-long part is said to be one-third (1:3) scale or proportion.

If a model is to be built to a scale of $6'' = 1'0''$, that means the finished model will be one-half (1:2) scale, or one-half the size of the real thing. A replica modeled to a scale of $3'' = 1'0''$ would be built to one-fourth (1:4) scale, or one-fourth the size of the original.

Of course, because of the size of the original, most models of things like buildings, automobiles, airplanes, and stage sets are built to an even smaller scale. For example, a model built to a scale of $1/4'' = 1'0''$ would be only $1/4''$ long or high for each foot of the "real" item. The proportion would be 1:48, or $1/48$ the item's actual size. That is because a one-foot ruler has 48 pieces that are $1/48''$ long.

Earlier, we said that one definition of *scale* is a ruler used by modelmakers and machinists. This isn't a ruler like you use in school, however, but a wonderful tool called an architect's scale. This triangular ruler displays 11 common scales and a regular one-foot ruler and helps modelmakers build models to almost any scale.

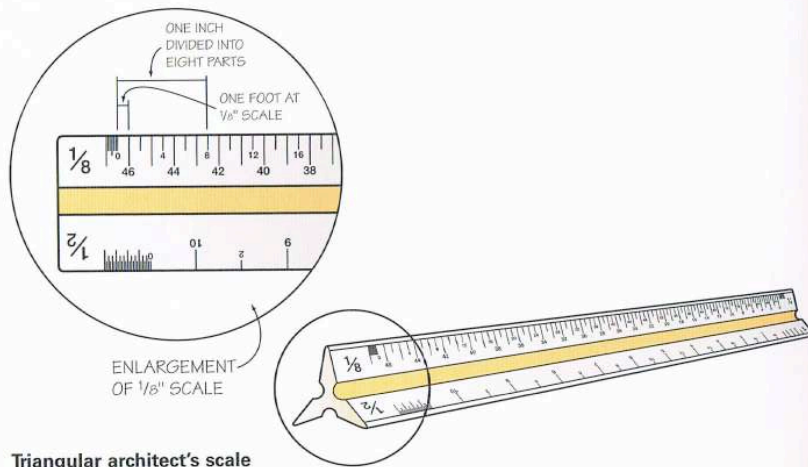

Triangular architect's scale

How is it possible to get so many scales on one ruler? Each side includes four different rules, two at the top and two at the bottom. In the illustration, you can see the $1/8''$, $1/2''$, and (at the opposite end of the ruler) the $1/4''$ and $1''$ scales. Unlike ordinary rulers, architect's scales have numbers running from left to right and from right to left. In the illustration, for example, the $1/8'' = 1'0''$ scale runs from left to right and is labeled 0, 4, 8, 12, etc.; the $1/4'' = 1'0''$ scale runs from right to left and is labeled 0, 2, 4, 6, etc.

Let's see how the $1/4''$ scale looks on the architect's scale. Notice in the illustration how the first $1/4''$ is divided into 12 small spaces. Think of that $1/4''$ section as a miniature footlong ruler. Each small space can then be used as a guide for $1''$ at the $1/4''$ scale.

Each scale on an architect's scale is read in a similar way. For example, look at the $3/4''$ scale provided in this book. At that scale, each "real" foot vertically or horizontally would be modeled as $3/4''$ long. Because there are 16 pieces measuring $1/4''$ in a one-foot ruler (count them and you will see), the ratio will be 1:16, or $1/16$ size. Every foot of the real object would be 16 times larger than the model.

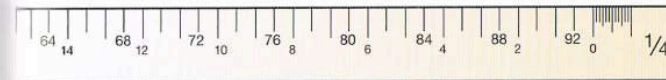

The $1/4'' = 1'0''$ scale, shown actual size

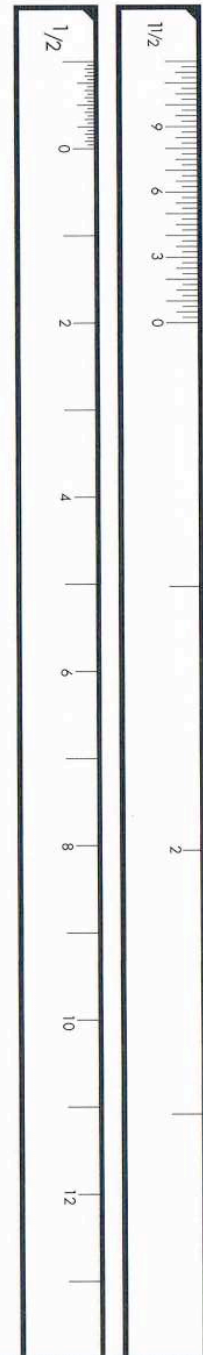
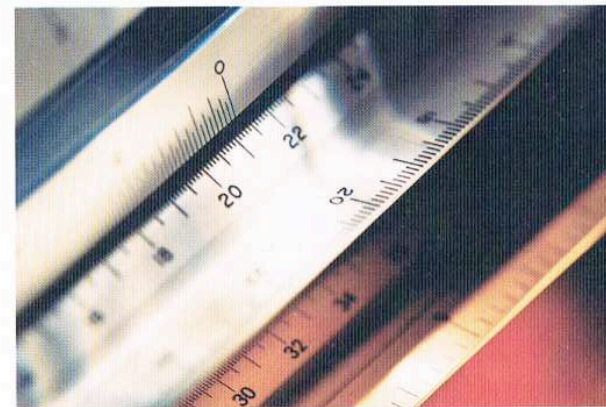

Reading an Architect's Scale

The following examples show how to read the $\frac{1}{4}$ " scale on an architect's scale.

How long is dimension A? _____

How long is dimension B? _____

How long is dimension C? _____

Check your answers with your merit badge counselor.

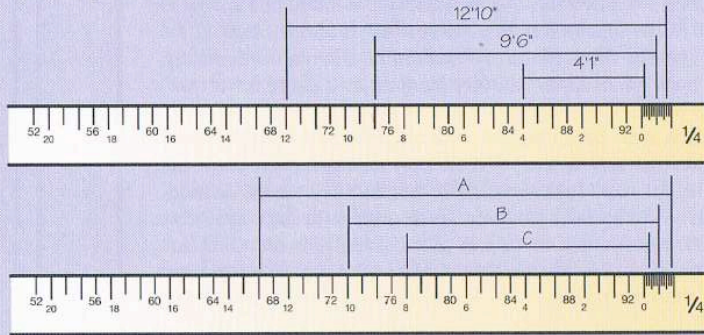

You can buy an architect's scale for a few dollars at an office or school-supply store. Learning to use this basic modelmaker's tool can be easier when you are holding the actual scale in your hands. You don't have to buy an architect's scale, however, to build your models for this merit badge. This pamphlet provides duplicates of the 11 scales on the architect's scale. When you choose a scale to build your model, simply cut the scale from the page and glue it to a piece of cardboard or wood. Be sure the marks line up with the edge of the cardboard.

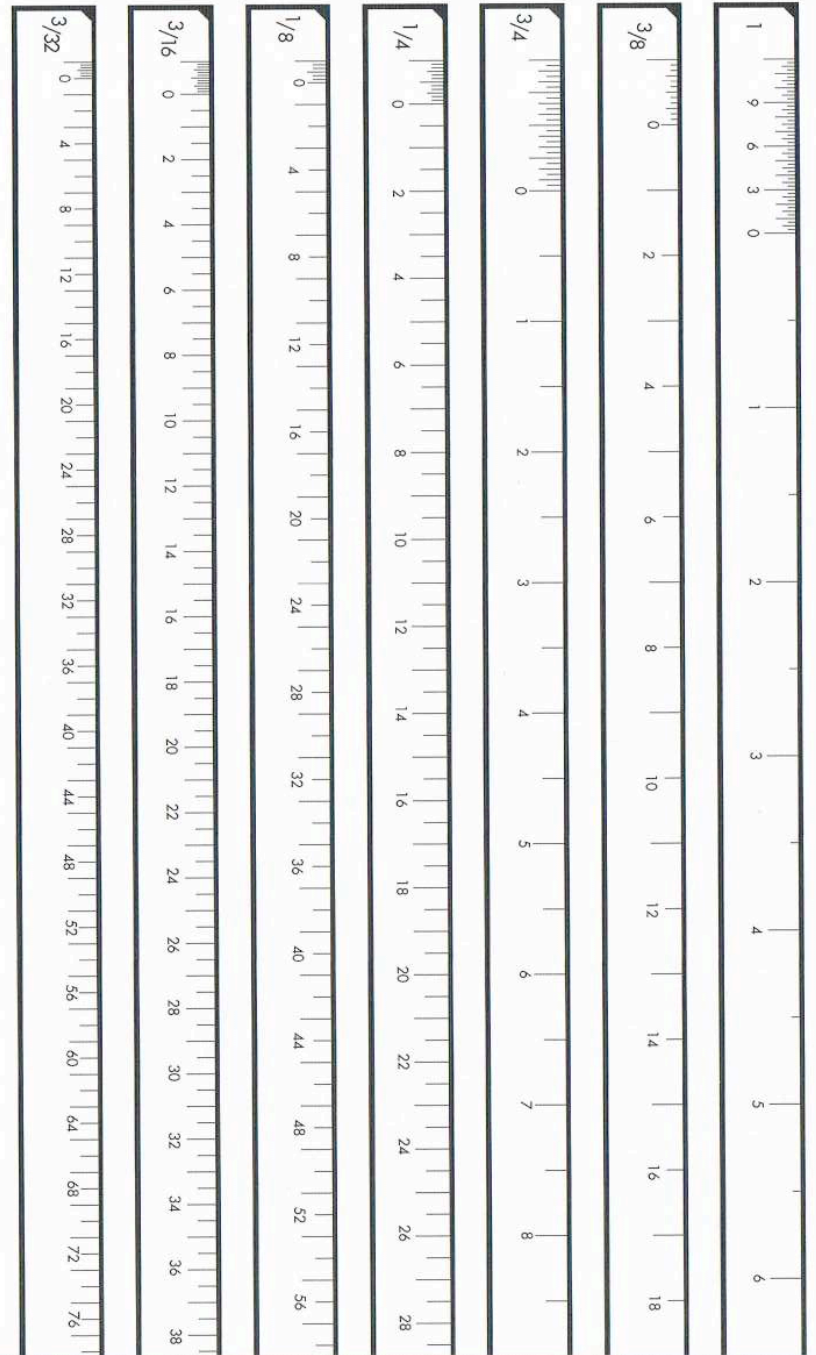
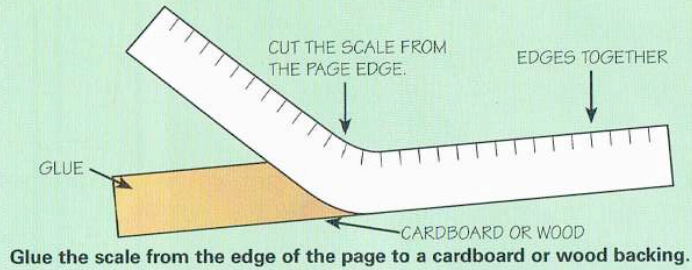

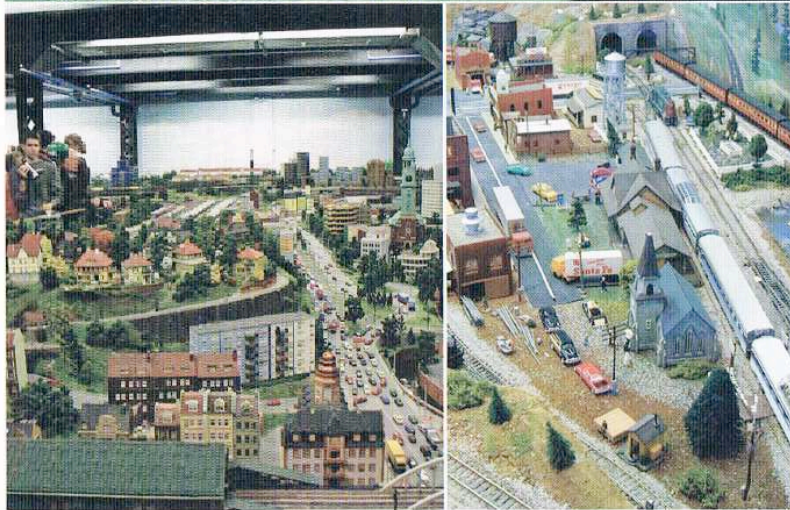
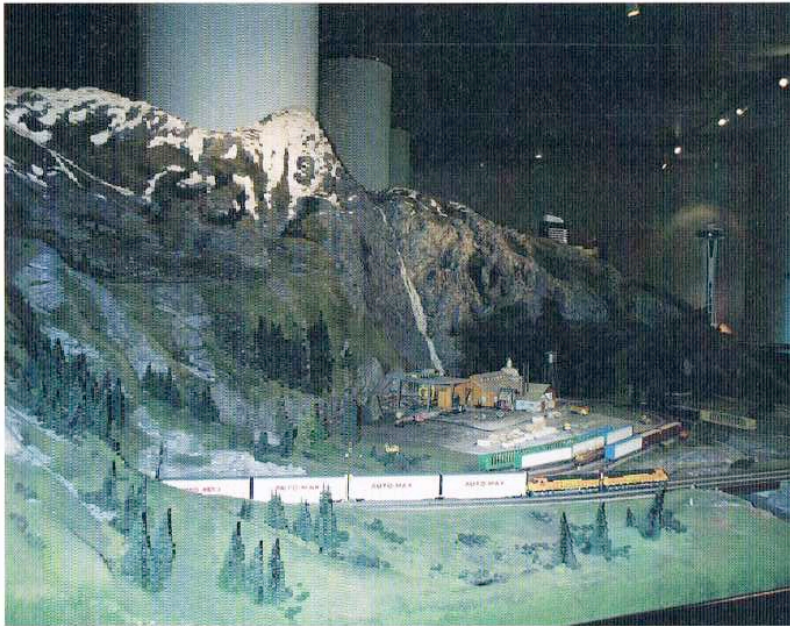

Materials and Finishes

Modelmakers are experts on materials and finishes. They use all sorts of surprising things for making models. A trip to a local model supply store will give you ideas, but you can also find many useful materials around your house. This section offers ideas about where to find modeling materials.

Glue and Paint

Most types of models require supplies like glue or paint. Be sure to use materials that will not damage your model. Some glues and paints contain *solvents* that can eat away the finish or materials of your model. Test the glue or paint by dabbing a little on a scrap piece to see what happens. Your counselor can also help you choose the right supplies.



When using glue, epoxy, paint, or thinners, be sure to read and follow the manufacturer's instructions. Work in a well-ventilated area so that you won't breathe in the fumes, which can be harmful. Avoid skin exposure when handling these products. Use protective nonlatex gloves as needed.

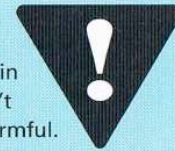

Wood and Polystyrene Foam

Wood is probably the most common material used for models. Wood can be nailed or glued with model-airplane cement, and it sands well for a nice finish. Soft woods such as balsa, pine, or basswood are ideal. You can buy thin sheets of such wood at hobby stores, or salvage them from orange crates and other packing boxes. Some models are made from larger blocks of wood and are carved or sawed to the shape desired. Large blocks of dense polystyrene foam work well, too.

Be sure the products you choose are compatible with the types of materials used in your model.

Material	Use on Model
 Tongue depressors, craft sticks	Wood or metal beams, house siding, links in a breadboard or 3-D mechanical model (which we will discuss later)
 Straws, uncooked spaghetti, dowels, coat-hanger wire, pencils, matchsticks	Pipes and columns, axles, push rods, dowels, fence posts, telephone poles
 Plastic foam meat tray (flat bottom)	House wall sections, inside walls, floors and other flat surfaces, staircases
 Straight pins, thumbtacks	Indicators of valve locations on straw pipes; temporary fasteners to hold plastic foam in place while gluing; pivot points for breadboard models
 Sandpaper (different colors)	Rooftops, blacktop driveways, textured surfaces
 Twigs from shrubs	Trees
 Cotton, lichens, sponges	Shrubs, tree foliage
 Plaster of paris	Irregular shapes
 Soup or vegetable cans, oatmeal canisters	Tanks on process models; rollers, large pipes
 Rubber bands	Belt or chain drives
 Cloth or canvas	Coverings for irregularly shaped surfaces
 Clear bread wrappers, plastic wrap	Window glass
 Sewing thread	Cables, telephone wires
 Sawdust sprinkled over wet rubber cement and painted green	Grass

Cardboard

Another common material in model building is cardboard. Thick corrugated cardboard is the material used to make most moving boxes and packing boxes. Thinner cardboard such as that used to make shoeboxes and gift boxes can also be used. Manila file folders, an everyday office supply, are a source for very thin cardboard.

Many architects use foam core to build models. This inexpensive material, found at art supply stores, consists of a piece of plastic foam sandwiched between two sheets of poster board. It costs more than cardboard, but it is more effective for creating curves. Modelmakers cut foam core with a utility knife, which allows more precision on the cuts.

Materials and Uses

The chart to the left will help you get started collecting materials for your modelmaking project.

Selection

As you gather items for your model, select strong materials. For instance, you would not use thin cardboard or plastic foam as a pushrod in an engine model. The cardboard would buckle, and the foam might crunch. Something stronger, like wood or metal, would work. Similarly, a coat-hanger wire might bend if used for a long pushrod, though it might work well as a short one.

Craftsmanship

Consider craftsmanship when you assemble your model; make it look its best. In business and industry, models are often used to test how the real product will work, to help sell an idea, or to explain a mechanism or process to a client. Be sure to apply all your materials well so that your model looks polished and professional.

You can use adhesive tape on cardboard, but white glue and rubber cement hold better and are more permanent.

Remember, choose your project and get your counselor's input and approval before you begin. Use your resources wisely.

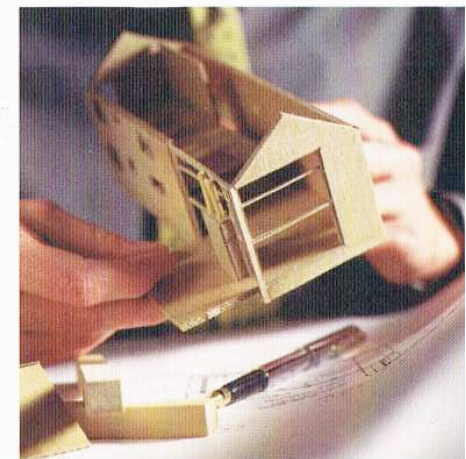



Architectural Models

Architecture is the art of designing buildings. Architects and engineers often use models to show, in miniature, how buildings they design will look before construction begins on the full-scale structure. Models are important design aids because even the most careful drawings and blueprints will not include all the details that can be shown in a model.

For requirement 4, you can create a model of your family home, a famous building like the White House, or an elaborate tree house. Or maybe you would rather build a frontier fort, a futuristic home, or the living quarters of an orbiting space station.

Plans and Materials

First, draw a floor plan of the building you want to model. If you are making a model of an existing structure, draw a floor plan based on your careful measurements. Check your local library or a building-supply store for ideas.



You can use the sample floor plan shown here, or base your design on a floor plan found in a book or magazine.

Drawings are flat, or two-dimensional, while a model shows a structure in three dimensions.

Use your imagination, and experiment with creative types of construction and unique styles. Some hobbyists build elaborate model houses using building materials such as plastic, foil, or polystyrene foam.

The sample plan is drawn to a scale of $\frac{1}{8}'' = 1'0''$. Thus, the outside dimensions of the house— $32' \times 56'$ —are drawn on the plan as $4'' \times 7''$. The height of the house is not shown, but for a typical one-story house you can assume a standard height of 8' from the top of the foundation to the *eaves* (the overhanging edges of the roof). Usually, there is another 4 feet from the eaves to the peak of the roof. Requirement 4 specifies that the model be built to a scale of $\frac{1}{4}'' = 1'0''$. This means that a model based on the sample floor plan would measure $8'' \times 14''$ and be 3" high from foundation to roof peak.

Use the floor plan's dimensions in measuring and marking the building materials for your model. You may use wood or cardboard. Cardboard is inexpensive, easy to get and use, and durable if treated with reasonable care. Wood is strong and attractive, but heavier and more difficult to manipulate.

If you choose wood, consider using *lattice* wood from a lumberyard. Lattice wood is a $\frac{1}{4}''$ -thick wood that comes in long strips in widths from about $\frac{3}{4}''$ to 3". An 8' strip of lattice wood $1\frac{1}{2}''$ wide costs very little and can provide a large amount of the material required for a fair-sized house model.

Steps in Assembly

The following drawings illustrate some basic steps in modeling a simple building.

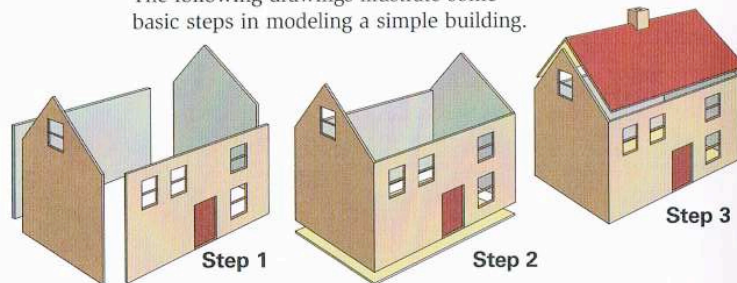

Basic steps in assembling a house model

Step 1—Construct the base of the house first. This will allow you to see the width of the walls. Measure the base by placing a copy of the floor plan over your base material. Make sure it is to scale, then cut out the dimensions for the base.

Step 2—Measure and cut out the exterior walls. Draw and cut out the window and door openings. (It is easier to cut out door and window openings at this stage, while the walls can be laid flat on a work surface. It is much harder to make neat openings after the walls are fastened together.)

Step 3—Apply glue to the edges and assemble the walls. Glue the walls to the base. If you plan to later add a porch, walkway, shrubbery, trees, or other outside features (be creative!), extend the base far enough beyond the walls of the house to allow room for the additions.

Step 4—Make a peaked roof from one large piece of cardboard, scored and folded at the peak. To *score* cardboard, make a shallow groove by running a dull knife blade along the line where the fold is to be. A butter knife works well. Use a ruler as a guide so that the score and the fold will be straight. Make the score on the inside of the fold—in this case, on the underside of the roof. If you want a detachable roof (so you can look inside the model or add interior walls later), do not glue it down. Cut the roof so that it hangs slightly over on the ends and sides.

To make a basic house model more realistic and attractive, add some architectural details.

- Cut and fold cardboard to form a front porch and steps, or make them from blocks of wood.
- Use thin strips of wood or cardboard to add shutters, window frames, and door frames.
- Use clear plastic or transparent adhesive tape for windowpanes. Glue colored tissue paper or fabric behind windows for curtains.
- Attach an extra room or shed simply by adding a box to the main structure.
- To add a chimney, first fashion a small box. Then, cut an angled notch from the bottom of opposite sides of the box to fit the slope of the roof.
- Add interest to a large, unbroken expanse of roof by attaching dormer windows as shown in the drawings.

Think outside the box as you design your building. The cardboard tubes on which aluminum foil, plastic wrap, and toilet paper are wrapped can be used to create castle towers or round rooms in a modern office building or transfer tunnels in a space station.

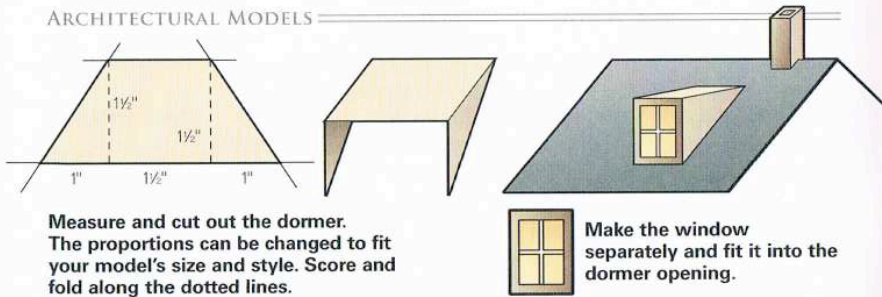

Measure and cut out the domer. The proportions can be changed to fit your model's size and style. Score and fold along the dotted lines.



Make the window separately and fit it into the domer opening.

Outside Treatments

Finish your architectural model with an interesting surface texture or treatment. The following are ideas for wall and roof finishes.

Walls

- Paint or stain shutters and door and window trims a contrasting color from the walls.
- Draw light pencil lines to look like wood siding.
- With a pointed tool, scribe shallow, parallel grooves to look like tongue-and-groove siding.
- Glue on strips of thin cardboard or balsa wood to resemble clapboard siding. Clapboard (pronounced "KLA-bird") siding consists of boards that are overlapped horizontally. Vinyl siding usually mimics the look of clapboard siding.
- To create a concrete effect, apply a sand texture. Paint a heavy layer of glue onto the walls. Sprinkle on a handful of fine sand, such as that used in aquariums. Let the glue harden, then tap off the extra sand. Try substituting sawdust or ashes for sand to create unusual surface textures and finishes.
- For a stucco effect, brush a little water over each unattached cardboard wall section and apply an even layer of white glue. Sprinkle generously with plaster-repairing powder, then tap off the extra powder. Lay the wall facedown on a clean piece of cardboard and rub the back to make the treated surface smooth. Turn the wall faceup and let the glue set.
- To color the walls, use spirit-based wood stain, shellac, or paint. When the paint has dried, back each wall with a piece of thick cardboard for extra support.

When choosing materials, try to find finishes such as paint or varnish that can be used on several different (or all) parts of your model.

- Apply individual cardboard "bricks." Cut small rectangles from colored cardboard and glue them onto the walls. To keep the rows of brick even, draw guidelines or glue graph paper onto the walls. Spread enough white glue over a section of wall to lay about three square inches of bricks at a time. Position each brick with the point of a knife. To get a red-brick look, paint the walls with a wash of mahogany wood stain. Use shellac to imitate yellow bricks.

For the most realistic effect, overlap and stagger each row of tiles.

Roof Surfaces

- Lay cardboard tiles. Cut individual roof tiles from very thin cardboard. Mark guidelines on the roof to help you keep the rows even as you glue on each tile, using the point of a knife to accurately position each one. Cap the peak of the roof with ridge tiles. To make ridge tiles, cut a narrow strip of thin cardboard. Score it down the middle and then cut the strip into individual tiles. Fold each tile in half along the score line and glue it onto the roof ridge. Color the roof with a wash of mahogany wood stain. Or, to mimic roofing slates, color with gray, blue, and white washes.
- Use masking tape to imitate wooden shingles. Cut rectangles from strips of masking tape and apply the tape shingles in the same way as cardboard tiles. (Use wood stain to color the roof and to dull the shine of the masking tape.)
- Glue on straw or reeds to create the effect of a traditional English thatched roof.
- Apply aluminum foil to suggest a metal roof. Overlap strips of foil and fold the strips together with raised seams to show the different panels of metal and how they interlock.

Remember, the more detail you add to the model, the better it will look.

Apply sand, stucco, and brick effects before the walls are glued together so that you can work with the walls laid out flat.

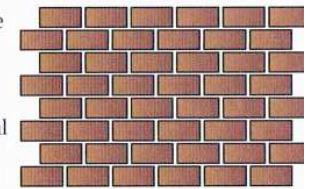

Running bond

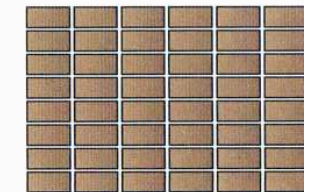

Stacked bond

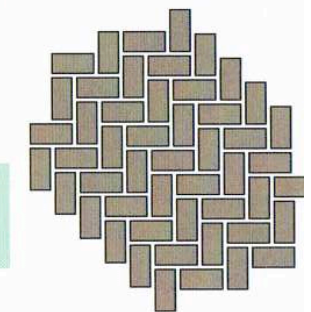

Herringbone

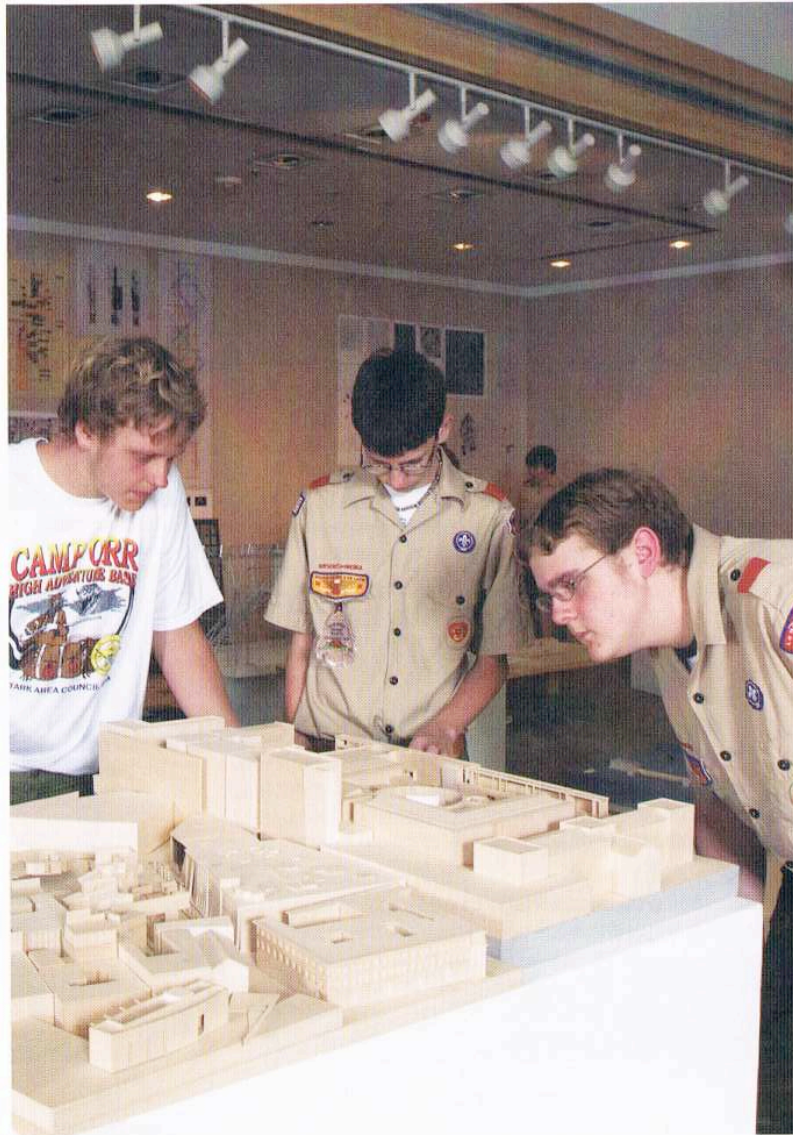

Structural Models

An architectural model shows what a building will look like, but it doesn't necessarily show how the building will be constructed. The walls and roof in an architectural model might be little more than flat sheets of cardboard or wood, leaving out studs, joists, and other parts that real buildings require. A structural model, however, shows details of construction. The individual pieces that make up floor, wall, and roof structures are reproduced in miniature.

One option for requirement 4 is to build a model showing corner construction of a wood-frame building. If you have never helped build a house or watched one being built, you will need to understand some basic concepts before you can build an accurate construction model. The next section outlines basic steps in framing a home's floors, walls, and roof supports.

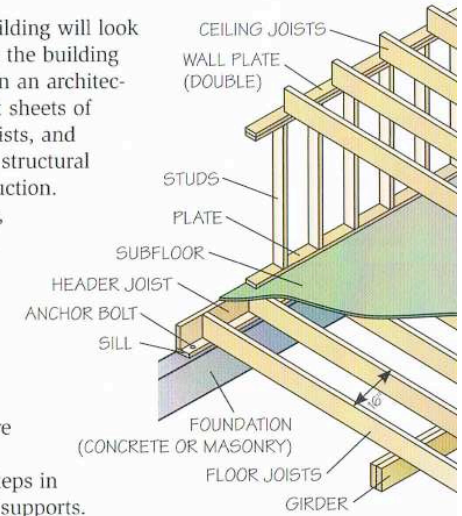

Framing

Wood-Frame Construction

Most houses are built on concrete slabs or masonry block foundation walls. The first wooden member that goes on the foundation is the *sill*. Sills are placed flat (horizontally) on top of the slab or concrete foundation walls all around the structure and are secured to the foundation with anchor bolts. The material typically used for sills is 2"-by-6" lumber, known to builders as 2 × 6s.

Regional building codes may require the doubling of the sill plate due to the threat of heavy winds or earthquakes.

The actual dimension of a 2 × 6, when cut, will shrink to around 1½" × 5½" because of the seasoning and surfacing of the wood. *Seasoning* refers to the natural drying of fresh-cut lumber, and *surfacing* is the smoothing of any rough edges after cutting.

The lumber should be long enough, if possible, to run the full length of the walls. Otherwise it can be butted end to end.

Floor joists are horizontal members of the structure, placed on edge, that span the foundation walls. Joists run parallel to one another and are evenly spaced between the sills. In house building, the spacing of joists is fairly standard at 16" from the center of one joist to the center of the next, but the spacing can vary greatly depending on the load, or weight, the joists will be carrying. The depth of the floor joist can vary according to the length of the span. Floor joists should be a minimum of 2 × 8 and are usually 2 × 10. For your purposes in designing a structural model, you may assume that the joists are 2 × 8s spaced 16" apart, with a span of 12'.

Because the span is only 12'—not long enough to reach the entire distance between the exterior walls—the joists will need supports, called beams or *intermediate girders*. The ends of the girders rest on the exterior walls in special pockets provided for them. The girders are themselves supported between the exterior walls on posts. Girders can be solid blocks of timber, but more commonly they are built up from two or more layers of 2"-thick lumber. For your purposes in modelmaking, assume that the girders are 4 × 6s—that is, they are built up from two layers of 2 × 6s—and are spaced 6' apart.

Floor joists that are too short to run the entire length of the structure must be pieced together. They are overlapped where

they cross the girder. Solid *bridging*, rows of diagonal braces, can be nailed between them for support or installed at other points between joists to keep them fixed and straight. A common system of bridging uses pieces of 1 × 3 or 1 × 4 lumber set between joists as shown in the illustration. The bridging should be in a straight line at a spacing of 8' or midway between the foundation wall and the girder as shown in the illustration.

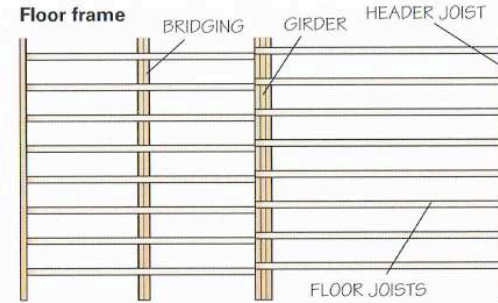
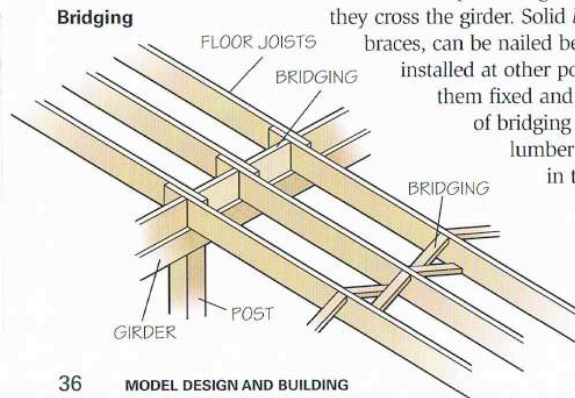

Floor joists are boxed in by headers that run across the ends of the joists. The headers are attached to the sills.

On top of the floor frame formed by the joists and headers, common 1" boards or 5/8" plywood sheets are placed to form the *subfloor*. The subfloor adds rigidity to the structure and acts as a base for the final, finished floor.

The top plate is a doubled 2 × 4 (or 2 × 6 if the wall frame is of 2 × 6 studs). "Doubled" means that two pieces of lumber are used to create a double thickness.

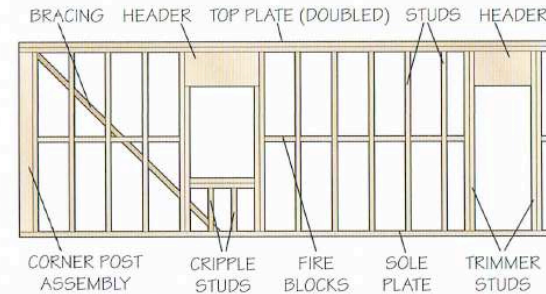

Wall frame

Wall frames are installed next. They support upper structures like ceilings and roofs and act as bases on which the builder can fasten exterior and interior wall coverings. Inside the wall frames between the coverings, there is room for other house essentials such as electrical wiring, telephone and networking cables, water and gas pipes, and insulation. Ducts for heating and air conditioning are usually laid above the ceiling or, in a two-story building, in *duct alleys* constructed separately from wall frames.

The lowermost member of the wall frame is the *sole plate*, a long piece of 2 × 4 lumber placed flat and nailed along the edge of the subflooring. *Studs* are the upright or vertical members of the wall frame. Studs usually are 2 × 4s, but 2 × 6s may be used if a thicker wall is desired (usually to allow more space for insulation). Studs are nailed to the plate. They are typically spaced either 16" or 24" apart.

If 2 × 6 studs are used, the sole plate will also be of 2 × 6 lumber. *Trimmer studs* placed beneath door and window headers and *cripple studs* beneath window openings are essential.

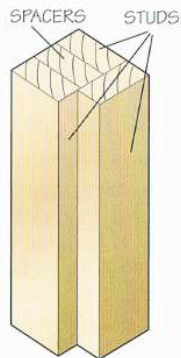
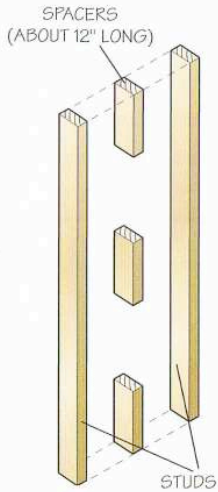

Outside-corner post assembly

Assemblies of 2 × 4s or 2 × 6s called *posts* are used at the corners of wall frames. A basic post design uses two studs and three spacers nailed together to form a solid unit. When the post is for a corner, a third stud is added as in the illustration.

Ceiling joists top wall frames. They act as ties between opposite walls and support the ceiling. Like floor joists, they are horizontal members of the structure placed on edge. They run parallel to each other and are evenly spaced, usually 16" apart.

Rafters are sloping timbers that support the roof. Rafters typically are spaced 16" to 24" apart.

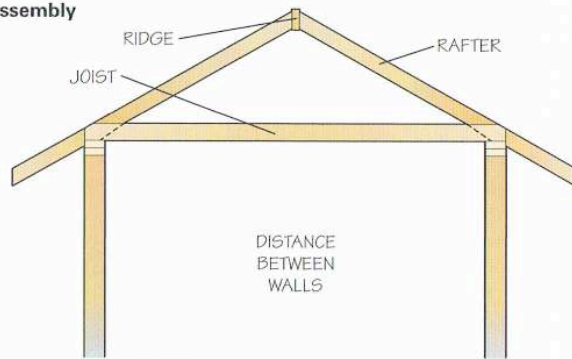

Ceiling joist

Unlike floor joists, ceiling joists have no headers around the edges.

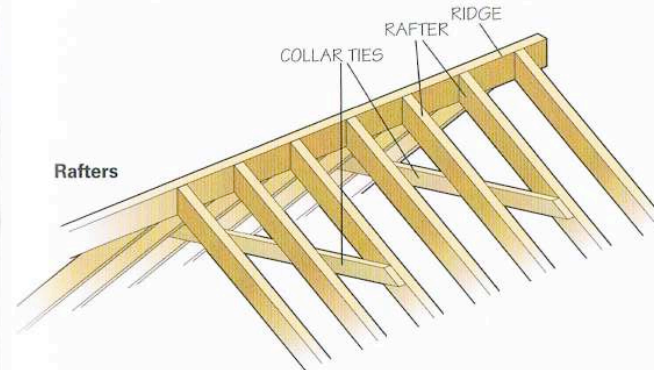

Rafters

Rafters are sloping timbers that support the roof. Rafters typically are spaced 16" to 24" apart.

Building to Scale

The structural model for requirement 4 is to be built to a scale of 1½" = 1'0". At this scale, 2 × 6 lumber would be represented by strips of wood ¼" thick by ¼" wide. To model a 2 × 4, use a strip ¼" thick by ½" wide. For a 2 × 8, use a strip ¼" thick by 1" wide.

Before beginning to build your model, prepare a supply of miniature 2 × 4s, 2 × 6s, and 2 × 8s. Also prepare the other necessary building materials to the same scale. You might need small pieces to use for bridging, and cardboard or flat sheets of wood stock for flooring. Although nails or screws would be used to hold the various parts together in full-scale construction, you may use glue in making your model.

Study the illustrations carefully to see how the subfloor, wall, and roof structures in a wood-frame building work together to support the building. In constructing your model, work slowly and let the framework dry between steps. If you rush the project, you could end up with a messy pile of wooden sticks instead of the strongly built, accurately scaled, and professionally constructed model you want.



Process Models

Architectural models show how buildings look. Structural models show how buildings are constructed. Process models show how buildings work.

Engineers build process models to show on a small scale what a building such as a manufacturing plant will look like and how it will operate once it is constructed. Such models demonstrate in three dimensions the placement of equipment, pipes, and other components. Viewers can easily understand process models because they look just like the real thing, only smaller.

All sorts of companies use process models. They include pharmaceutical companies that make vitamins and other medicines, food companies that make and package everything from popcorn to soda pop, and chemical companies that create inks, dyes, and paints.

Types of Process Models

There are two types of process models: *planning models* and *final construction models*.

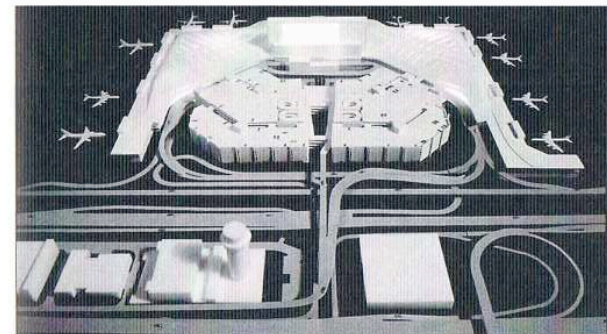

Planning model

Equipment can be modeled to any degree of detail desired. It can be made of wood, cardboard or plastic boxes, cardboard tubes, or any other material that is easily adapted to the shape needed. The chapter "Materials and Finishes" lists some materials useful in building models.

A planning model is simple. It is usually made of inexpensive materials and is assembled quickly. It conveys an idea of the general location of pipes and equipment. You could use wood, cardboard, string, blocks, foam, or any material that is handy. The idea is to show the concept, not the details; a preliminary planning model does not include a lot of detail. Equipment is shown as plain blocks, and usually only large groups of pipes are shown. The main purpose of a planning model is to see if pipes and equipment will fit into the spaces available.

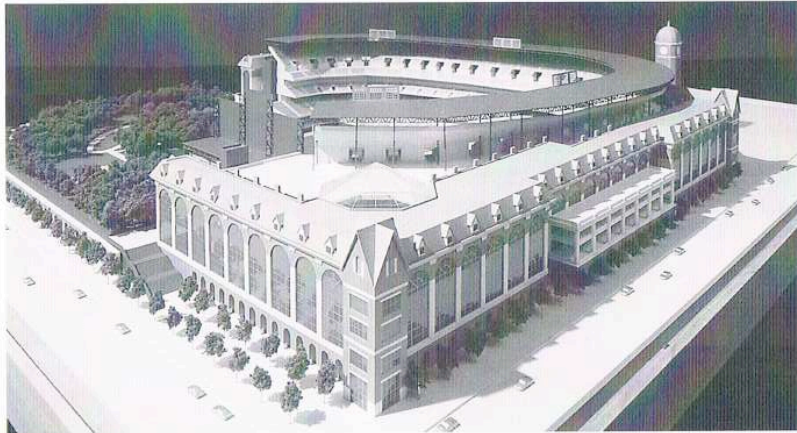

Final construction model

A final construction model, from which construction workers actually build the full-size plant, is much more complex, accurate, and expensive. It shows far more detail than the planning model. Equipment is modeled in exact detail and with great accuracy. Instead of showing pipes as blocks of materials, each pipe is shown individually.

A *tank* is a tub used to store a liquid, a gas, or a product.

Advantages of Models

Building a model before beginning actual construction has many advantages. During the design stage, a model allows you to see problems easily. For example, you might spot places where two different things will try to take up the same space or notice a piece of equipment that sticks out into an aisle or hits a tank.

Because a three-dimensional model shows the length, width, and height of equipment, layouts can be more accurately assessed. Engineers can decide the best locations for welding, for pipe and equipment supports, for water-hose stations, for lights, and for items such as valves. Items such as safety showers (where operators accidentally splashed with acid can be drenched with water) are easily placed on a model.

One primary advantage of a process model is that architects, piping engineers, and machine designers can get together and use the model to work out problems. All the engineers can coordinate their work through the use of the model. When the process model is complete, it can be used not only for construction purposes, but also, in many cases, to train the workers who will operate the final plant after it is constructed.

What Process Models Show

Now consider the details found in a process model.

Building Structure

After deciding the size (scale or proportion) and shape of the model, the modeler makes the structure to enclose the plant. The building structure can be made of wood, plastic, cardboard, or any other suitable material. Beams and columns are usually shown to the largest outside dimensions or, to be more realistic, the actual shape may be shown.

The modelmaker might want to show only partial walls in some material. This is called "dodging in" a wall, used when the modelmaker wishes to leave access to work on the model. With complete walls, no one could get hands or tools in to work on the model.

Equipment Layout

Place equipment in the model in its exact location. Ensure that it is accurately positioned and that there is enough space to get around the equipment. A good rule is to allow a 36" (3') minimum access around each piece of equipment.

Remember, at a scale of $\frac{3}{4}" = 1'$, which is the scale specified in the requirement, $\frac{3}{4}" \times 3 = \frac{9}{4}" = 2\frac{1}{4}"$. In other words, you would need to leave a space of $2\frac{1}{4}"$ around each piece of equipment in the model to represent the 36" minimum access required in the actual plant.

Fire protection can include fire hydrants, hoses, and sprinklers used to put out fires.



Structure refers to the building or framework used to enclose the process.

Instrumentation is a term for automatic devices used to operate valves, take readings, show temperatures, etc. A *valve* is a device, such as a faucet in a bathroom, that controls the flow of a liquid or gas through a pipe.

Pumps can be used to force a product through a pipeline regardless of slope.

Piping

Piping takes careful thought and planning before installation. When many pipelines are to be shown, the modelmaker must consider their order of placement, the size of the pipes, how they will be supported, and how a worker would reach any valves that might control the pipes. In positioning pipes, designers and engineers must try to use the minimum number of fittings required to get from one point to another. Unnecessary fittings increase the cost of materials and the cost of labor to install them.

Other things to consider are head clearances (room to walk or pass underneath) and *sloped lines*. Sloped pipelines are those that rely on gravity for drainage. In basements you will see sloped sink and toilet drainpipes.

Piping is hollow tubing used to move a liquid, a gas, or a product from one place to another. A *tee* is a fitting used to branch off of a pipe to go in another direction. An *elbow* is a fitting used to change the direction of a pipe.

HVAC stands for heating, ventilation, and air-conditioning.

Heating and Ventilating

Another important feature of a process plant that can be shown on a model is heating and ventilating equipment and ductwork. This equipment heats and cools the building and provides good ventilation. Ductwork is the system of tubes through which warm or cold air travels. Equipment and ductwork must be installed so that pipes, electrical wires, and other equipment do not interfere with the ducts.

Instrumentation and Electrical Conduits

Most equipment needs electricity to operate. In process plants, electrical signals from different types of instruments control the equipment. Electrical equipment can include automatic valves, switches, transmitters, and recording devices. Therefore, it is important that electrical conduits and instruments be properly installed.

Building a Process Model

Now that you know what kinds of things can be shown on a big industrial process model, you are ready to build a similar, though simpler, model of your own. Requirement 4c asks you to build a model showing your home's plumbing system.

Almost everyone is familiar with a home's water system. Water is piped into a house; some of it is left cold and some is heated. The water is then distributed throughout the house. Your model will show how this process works behind the walls and under floors.

The illustration here depicts a flow diagram of a simple water system you can use as a guide in building a model of the plumbing system in your home. Your home's plumbing might have more attachments on the pipelines than shown in the diagram. Look for all of them. If you have a question about what you see, ask your counselor. If you have radiators in your home, ask an adult to explain how they work.

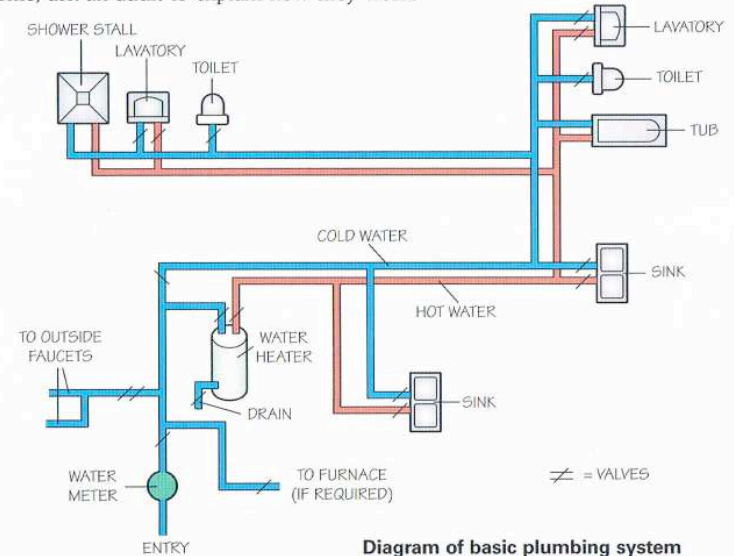

Find out where the main shutoff valve is in your home's water system. In case of an emergency, such as a burst pipe, cutting off the water supply can prevent thousands of dollars' worth of damage.

Mechanical Models

People in a wide variety of occupations use mechanical models, or models of mechanisms. These models are an easy-to-understand way of presenting and communicating ideas. Machine designers use them to find answers to complex machine questions. Tool and die designers use them to determine the proper tooling and dies to use on machine tools. Engineering firms use many types of models, including research and development, automotive, and mechanical models.

A machine tool is a machine for shaping metal. A die is a tool or form used for cutting or shaping metal or other materials.

LEVER

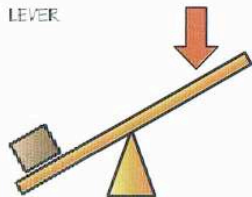

PULLEY

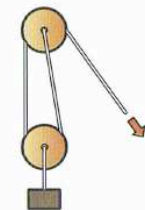

INCLINED PLANE

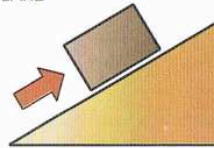

WHEEL AND AXLE

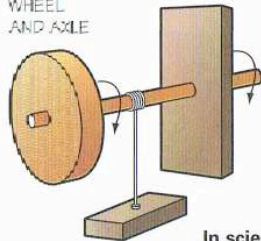

SCREW



WEDGE

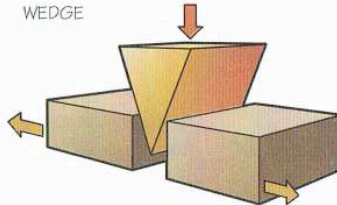

In science class, you have probably learned about these six simple machines: wheel and axle, lever, wedge, inclined plane, screw, and pulley. Mechanical models combine two or more of these machines to do some type of work.

Basic Mechanisms

Mechanical models include at least two of the simple machines mentioned above, used together. One of the parts, called the *driver*, is stationary, or held in one place. The other part, called the *follower*, moves. Sometimes the follower moves back and forth along a straight line. Sometimes it moves along a curved line or a circular path. Sometimes it moves only in part of a circle, called an arc.

The illustrations show examples of mechanical models.

Wheel and Axle

In the wheel and axle mechanism, the piston changes an up-and-down movement into a circular motion. Steam enters the cylinder and pushes on the piston and piston rod, which can only move up and down. The piston rod is attached to a connecting rod, which pushes the wheel around on its axle as the piston moves up and down. Most steam engines and gasoline engines work on this principle.

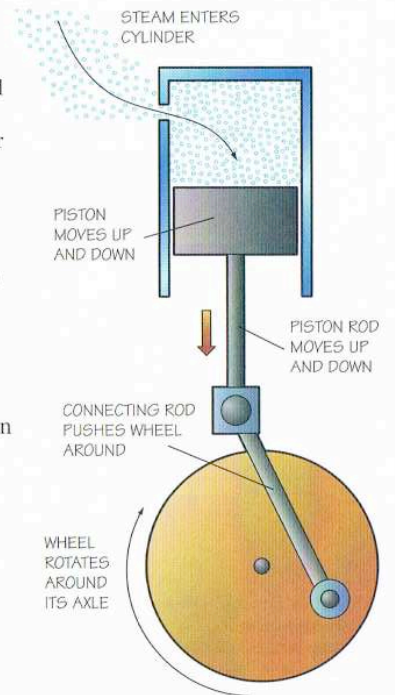

The piston's up-and-down movement is changed into circular motion.



Steam engine

Four-Bar Linkage

The four-bar linkage is the simplest form of movable linkage. It consists of four rigid bars or links, which are connected by joints or pivots. One link is usually fixed (it does not move) and is called the *frame* or *ground link*. Connected to this link are the two *grounded links*. One of these is the *input link*, which receives the external force; the other is the *follower link*, whose motion is determined by the motion of the input link.

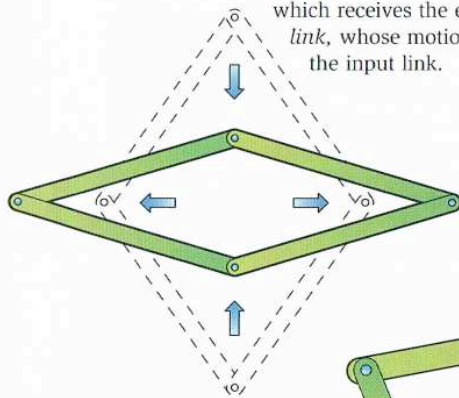

Four-bar linkage—the linkage of the four bars converts up-and-down motion into left-and-right motion.

This four-bar mechanism has a crank (the input link) that rotates in a complete circle and moves the follower link (the rocker) back and forth.

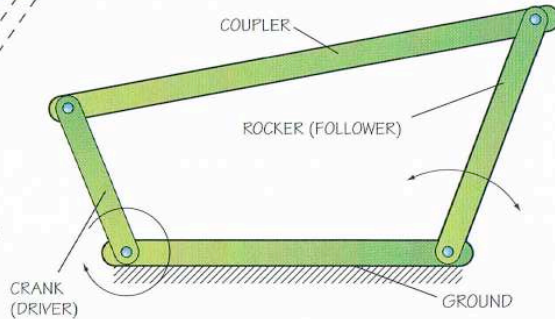

A four-bar linkage drives the motion of windshield wipers. Locking pliers are an example of four-bar linkage with the fixed link made adjustable by turning the end screw.

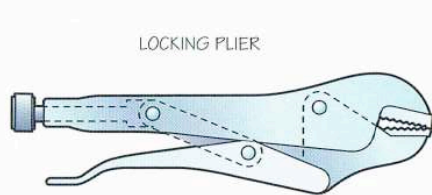

LOCKING PLIER

PORTABLE TOGGLE CLAMP

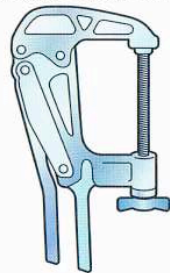

Tools that use four-bar linkages

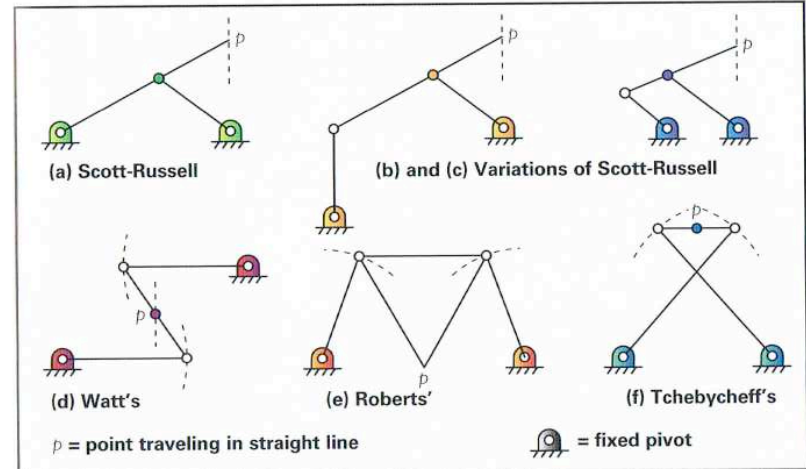

Straight-line mechanisms

Straight-Line Mechanisms

A straight-line mechanism causes a point to travel in a straight or nearly straight line. In the late 18th and early 19th centuries, a big problem facing engineers was how to make the piston rod in a steam-powered machine go straight. In 1784, James Watt, the inventor of the steam engine, came up with a workable solution. He used three rods connected as shown in the illustration; the midpoint P of the middle link travels in a straight line up and down when the other links swing on their pivots. Some say that Watt was prouder of this invention than of the steam engine that made him famous.

In 1850, a mathematician named Tchebycheff devised another solution to the problem of straight-line motion that may have been more accurate than Watt's but wasn't as practical. An Englishman named Roberts proposed yet another solution for a mechanism that traces a nearly straight line. These are shown in the illustrations.

To see these mechanisms in motion (which makes the whole idea much clearer), check out (with your parent's permission) the website <http://www.brockeng.com/mechanism>. Click on each of the mechanisms shown above and study their movements. Do you see the straight lines they trace?

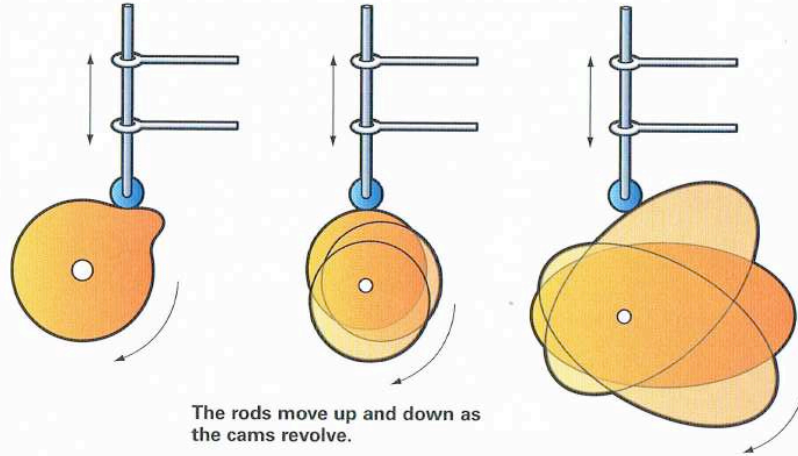

The rods move up and down as the cams revolve.

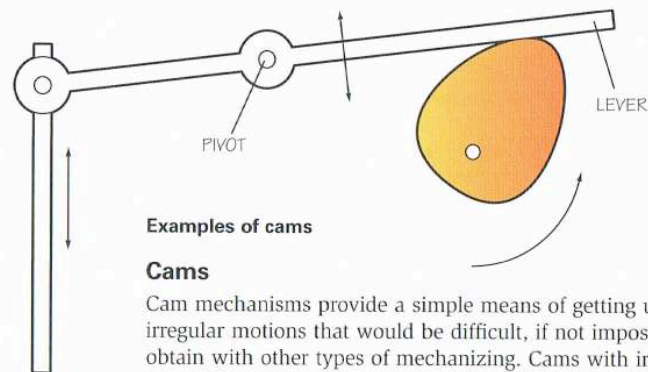

Examples of cams

Cams

Cam mechanisms provide a simple means of getting unusual or irregular motions that would be difficult, if not impossible, to obtain with other types of mechanizing. Cams with irregular or unusual shapes can be used to achieve a desired motion. In other cases a simple round or oval wheel mounted so that it revolves off-center will guide the follower in the desired motion.

Cams are the heart of such automatic devices as automatic machine tools. They are also found in all internal-combustion engines.

The *cam* is any guiding surface, and the *follower* usually is a small wheel that is either lifted or guided by the cam surface.

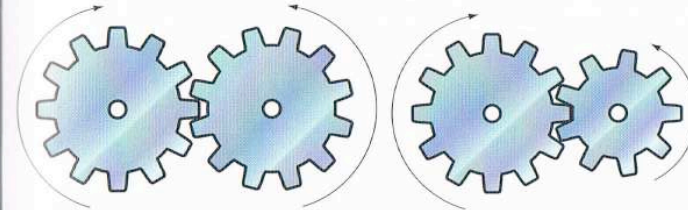

One gear turns in one direction, the other gear in the opposite direction.

The large gear on the left will turn more slowly than the small gear on the right.

Gears

Gears are toothed wheels used to accurately transmit circular motion from one part to another. The teeth keep the two gears locked together so that they operate smoothly without slipping.

To make two gears rotate without slipping but without touching, the modelmaker or engineer uses a chain to connect the two gears. A bicycle chain is a perfect example of this arrangement.

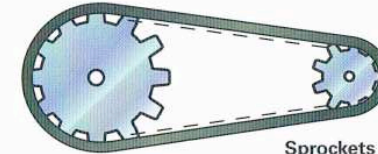

Sprockets

When referring to a chain drive, the designer or engineer uses the term *sprocket* instead of gear.

Building a Mechanical Model

Mechanical models are used in the first stages of design to ensure that a design will do what it is supposed to do. A flat, or two-dimensional, *breadboard* model is a very simple, easy-to-make type of mechanical model. You can cut its pieces out of cardboard, poster board, or paper and fasten them to a backing board with thumbtacks. The pieces can move or be fixed in place. Because the materials used are rather flimsy, this type of model has limited usefulness.

A prototype model is the first working model of a design; it is usually three-dimensional and full scale. It can be made of wood, plastic, metal, or another material. Design information gained from such models can be of real value.

When choosing a mechanical model to build, you might consider making a model of a two-wheel bicycle chain drive, a medieval catapult, or a big model of the squirting mechanism on a bottle of window cleaner. (Maybe you could even make it squirt water.) Use your imagination.

Before you start making your model, be sure to discuss your ideas with your counselor.

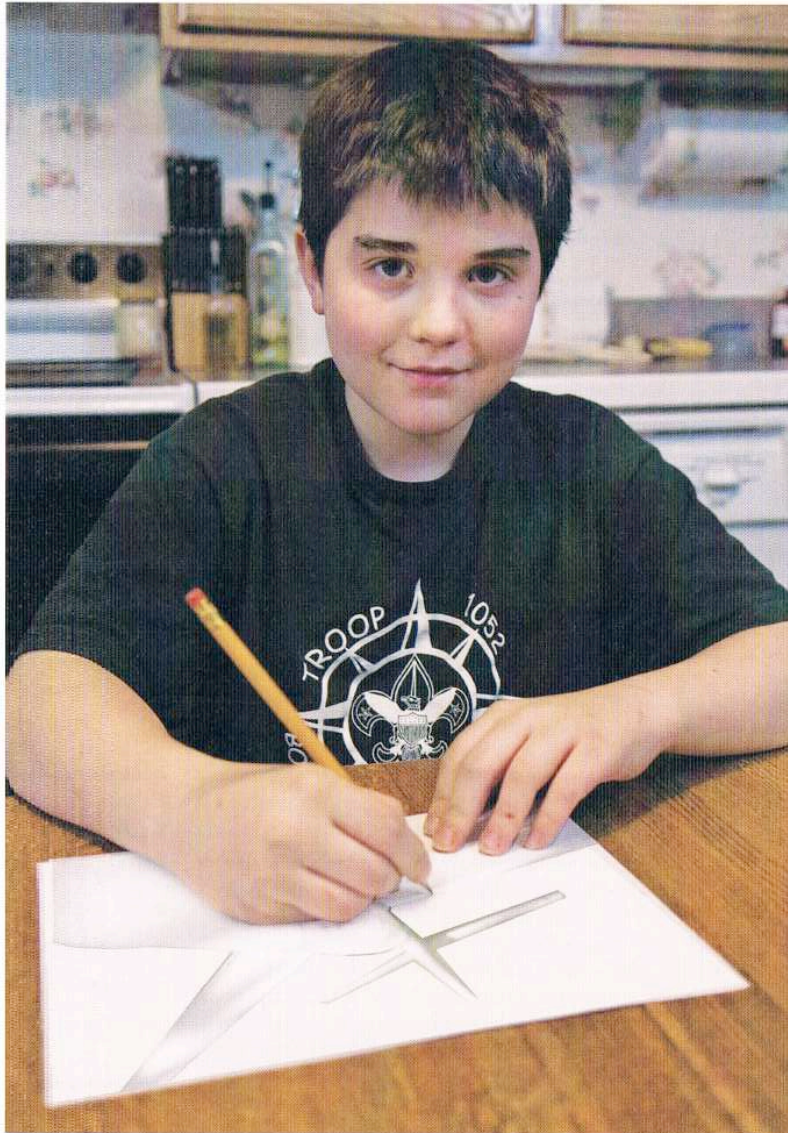

Industrial Models

Almost all products—cars, airplanes, toys, furniture—begin as models. As you have learned, models are used to demonstrate how something works or looks before it is manufactured or built. You may complete requirement 4 by building a model of a passenger-carrying vehicle. Be sure to get your counselor's approval before you begin.

Plans, Materials, and Tools

Several materials, including wood, clay, plastic, and cardboard, are suitable for building industrial models. Polystyrene foam or foam core are good choices for a car. They are inexpensive, easy to work with, and can be found at most hobby and art-supply shops. If you use foam, you will also need a water-soluble white glue (not plastic model cement), spackling paste (commonly used for patching cracks in plaster walls), a sharp knife, sandpaper, and paint.

Before you start, you must select a design—a two-door car or an SUV, for example. Then draw your design. Start your drawing with a side view to a scale of $1" = 1'0"$. Your drawing should include overall dimensions and important reference points. Working from front to back, these might include the distance from the ground to the bumper, the length of the hood, the distance from the ground to the roof, and so on. The drawing also should include front and rear views.

When you have completed your drawing, show it to your counselor. Discuss any questions and review the next steps. With your counselor's approval, you are ready to start building the model.

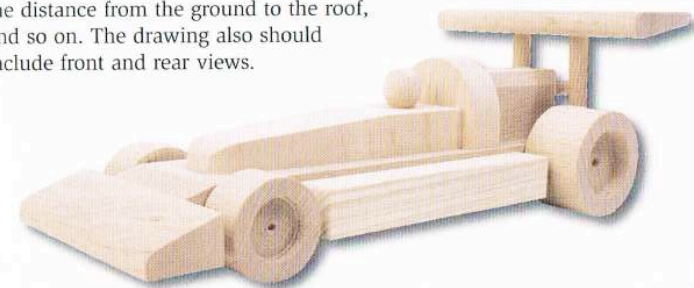

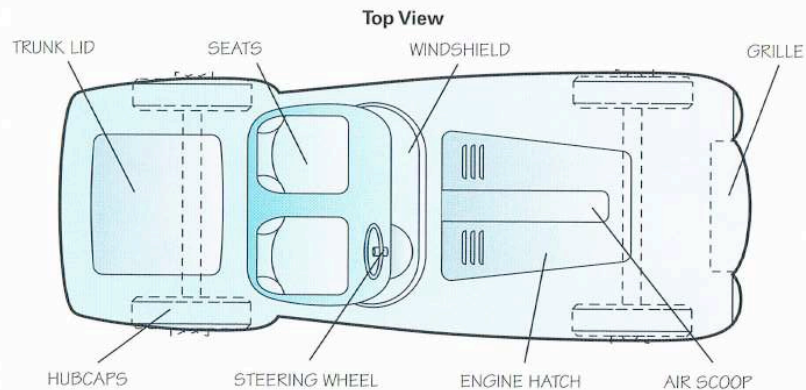
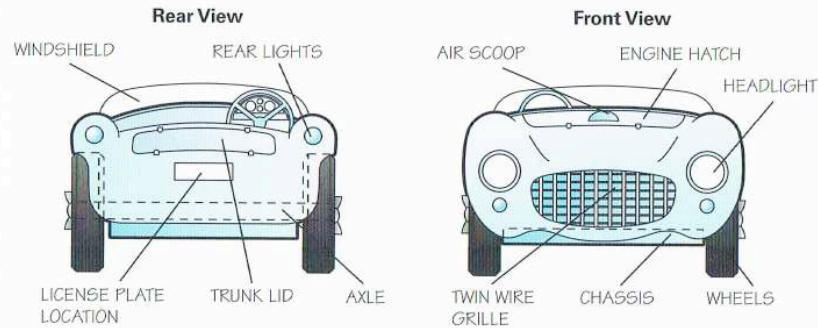
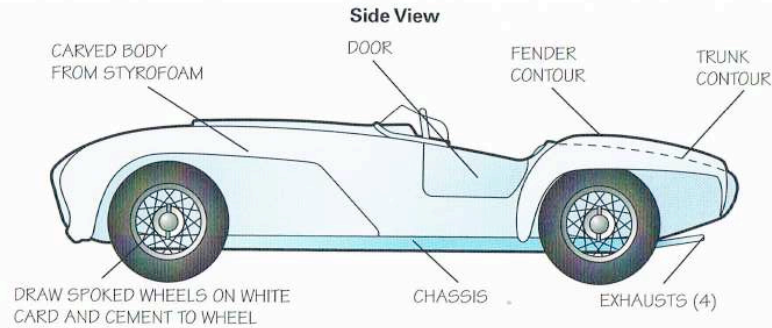

Transfer the outline of the side view to 1"-thick Styrofoam. Cut out five or six layers, depending on the overall width of the car. Each layer will be identical except for wheel openings in the outside layers. Glue the layers together.

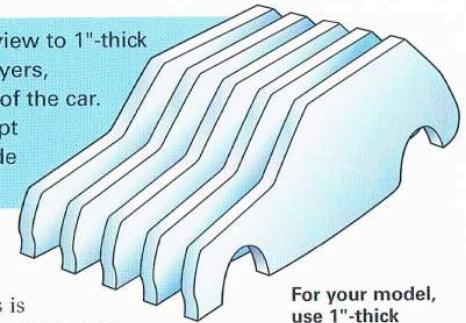

Making the Model

Transfer the outline of the side view from your drawing to the foam. This is best done by making a paper pattern and tracing around it. If the foam is 1" thick, you will need five or six layers, depending on the overall width of the car. Each layer will be identical except for wheel openings in the outside layers. Cut out all of the layers and glue them together with white glue. Let them dry for several hours.

When the glue has dried, you can carve the block. This step is intended to give the model its basic form, not its detail. An ordinary kitchen knife and a hacksaw blade make perfect carving tools.

After you have finished carving the shape, spread a layer of spackling paste over the foam. This will take several hours to dry, so set the model aside until the next day.

When the paste is thoroughly dry, lightly sand the model with fine sandpaper. Then, use a pointed tool and a fine file or piece of sandpaper to shape the details of the model. Scribe the outlines of window frames and windows, doors, hood, trunk lid, headlights, taillights, and so forth.

Make wheels and tires from disks of wood. Glue the disks into the wheel openings. For a more realistic effect, mount the wheels on axles of coat-hanger wire or a similar material so that the car will roll.

Paint Your Model

When the base coats are completely dry, you can add details such as racing stripes and chrome rims. Use a pointed fine-bristled brush for painting stripes, body side molding, numbers, and other delicate features.

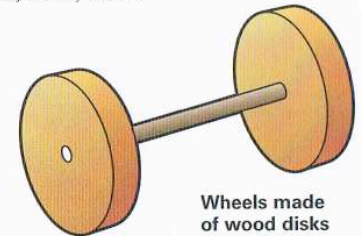

Wheels made of wood disks mounted on axles cut from a coat hanger

For your model, use 1"-thick plastic foam.

Do not use plastic model cement on foam. The foam will melt and the layers will not bond.



Mission: Fantasy Spacecraft

Thousands of hobbyists create models using kits that provide the design, parts, and accessories. All the hobbyist has to do is follow the instructions. For those who want to go a step beyond kits, there is kit-bashing—a more creative approach that uses parts from two or more kits to create an original design and model. Most kit-bashing projects use leftover parts from several kits, allowing you to use your imagination while taking advantage of the convenience of premade parts.

To complete requirement 5, you may choose to design your fantasy spacecraft using ordinary household items. The scope and detail of this project is up to you, using some general guidelines. The project should reflect what you have learned about designs and models so far—and your imagination.



The most difficult part of your project may be coming up with a design idea. Give yourself plenty of time to think of what your spacecraft will look like and what materials you could use. You will make your own instructions as you go along, so organization will be key.

If you kit-bash your spaceship, you will be following a grand tradition. For example, the Millennium Falcon model used in *Star Wars Episode IV: A New Hope* relied heavily on parts from off-the-shelf models.

To get started, study different designs of aircraft, ships, and submarines. Your local library and the Internet will have plenty of resources. (Surf the Internet only with your parent's permission.)

Look around your home for interesting materials to use. Also gather leftover pieces from other models you have made in the past.



You might also visit an interior-design studio or store and research different surfaces and materials. Or you might get some free samples to use in your model, and visit a hardware store to research various storage compartments. You could watch television programs about space exploration to find out about components on existing spacecraft. You might also request information from NASA through its Web site or through the mail.

When you are ready to begin, first determine the model's scale based on the materials you have. You will want the spacecraft to look as real as possible—it is to be used in a movie production, or at least that is the idea. List the tools you will need. Cut pictures or shapes out of catalogs, newspapers, or magazines to use as details on the spacecraft.

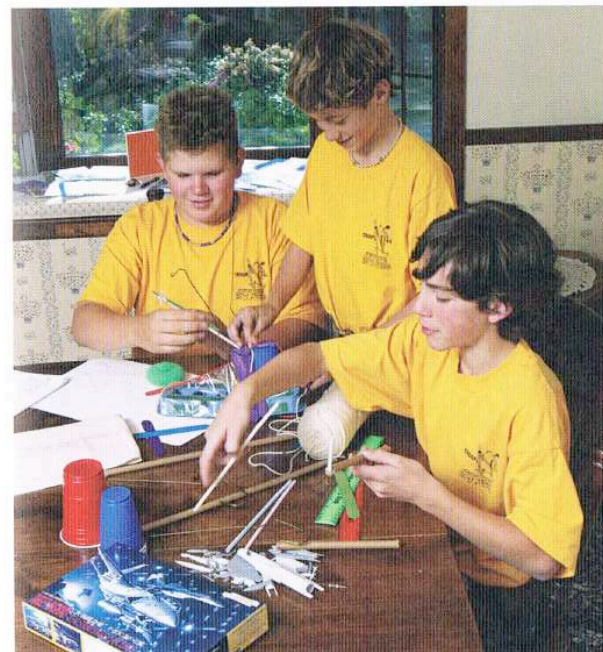

Part of being a Scout is adapting what you have learned and using it in everyday life.

Now, using what you have learned in this pamphlet, begin creating your design. Make detailed drawings of the craft, remembering your scale at all times. Think of how the model will look from different angles. Make sure all the parts fit together. There should not be any gaps between pieces.

Once you complete your model, write a short, straightforward essay explaining why you chose your particular design and how you engineered it. Describe the scale and materials used, and your reasons for choosing them. Also mention what you learned from the project, what challenges you encountered, and how you overcame them.

Make your model look more authentic. Add *nurnies* and *greebles*. Nurnies are features like extra vents or scopes that add complexity but have no real purpose. Greebles are details like boxes and ridges that break up the surface of a fictional spacecraft.

Computer models may replace scale models for some design purposes, but there will always be a demand for detailed, three-dimensional models.

Modelmaking As a Career

A wide variety of businesses have industrial modelmaking needs. In the movie industry, for example, designers use modelmaking skills to create sets and special effects. Architectural and graphic design firms also use models. Models have long been important in the automobile manufacturing industry.

Computer modeling and animation is a fast-growing career field. Computers are making it possible to "build" and display intricate models on-screen. Although such models have no physical form, they can be studied and manipulated on computer monitors in three dimensions much like scale models.

This profitable industry's need for trained technicians grows yearly. The resources section of this pamphlet lists several colleges and vocational schools that offer programs in modelmaking, modeling technology, or industrial design technology. Your merit badge counselor, teacher, or school counselor can also help you find information about additional training opportunities.



Professional modelmaker Steve Howarth adds surface detailing to this satellite for the movie "AVP: Alien vs. Predator."

Business Areas and How Models Are Used

Automobile industry: Sales, wind-resistance testing, safety design

Toy industry: Development and sales

Chemical and petroleum industries: Process piping design, offshore drilling rigs, ship design, dry materials handling

Office equipment manufacturing: Design, sales, human factors engineering

Film and theater industry: Stage sets, robots, spaceships, cities, planets, makeup

Machine tool industry: Movement and force studies

Building and construction (architectural/structural) industries: Buildings and houses, office layouts, site studies, urban planning, site reconstruction, and historical landscape effects

Environmental and civil engineering: Topography studies, pollution studies, river flows, dams, spillways

Sales: Backdrops, booths at conventions

Law: Crime-scene re-creations

Museum and park industries: Caves, physics demonstrations, historical rooms, artifacts, planetary systems, historical sites

Aeronautics: Wind-resistance studies, destructive testing, displays

Energy industries: Coal handling, solar-energy systems

Amusement parks: Rides, park layouts

Undersea and naval industries: Water-resistance studies, internal piping layouts, human environments, harbor studies

Medicine and science: Human and animal anatomy, molecular structure



Model Design and Building Resources

Scouting Literature

Architecture, Art, Auto Mechanics, Aviation, Engineering, Railroad, and Woodwork merit badge pamphlets

Books

For more information about or to order Scouting-related resources, visit <http://www.scoutstuff.org> (with your parent's permission).

Bridgewater, Alan. *Making Wooden Mechanical Models*. Popular Woodworking Books, 1995.

Bridgewater, Alan, and Gill Bridgewater. *Making More Mechanical Wooden Models*. F & W Publications, 1999.

Buckles, G. Matthew. *Building Architectural and Interior Design Models Fast!* Belpine Publishing, 1993.

Covert, Pat. *Building and Detailing Scale Model Cars*. Specialty Press, 2006.

FineScale Modeler. *Scale Model Detailing: Projects You Can Do*. Kalmbach Publishing, 1995.

Hansen, Lawrence. *Basics of Scale Modeling*. Kalmbach, 2005.

Leaf, Edwin B. *Ship Modeling From Scratch*. McGraw-Hill, 1993.

Levy, Raymond. *Making Mechanical Marvels in Wood*. Sterling, 1991.

Marmo, Richard. *How to Build Science-Fi Model Spacecraft*. Specialty Press, 2004.

Salvadori, Mario G., and Christopher Ragus. *The Art of Construction: Projects and Principles for Beginning Engineers and Architects*. Chicago Review Press, 2000.

Sutherland, Martha. *Modelmaking: A Basic Guide*. W. W. Norton, 1999.

United States Bureau of Naval Personnel. *Basic Machines and How They Work*. Dover Publications, 1971.

Wilson, Jeff. *Modeler's Guide to Realistic Painting and Finishing*. Kalmbach Publishing, 2006.

Magazines

FineScale Modeler

Toll-free telephone: 800-533-6644
Website: <http://www.finescale.com>

Model Airplane News

Toll-free telephone: 800-877-5169
Website:
<http://www.modelairplanenews.com>

Scale Auto Magazine

Toll-free telephone: 800-533-6644
Website: <http://www.scaleautomag.com>

Organizations and Websites

Academy of Model Aeronautics

Telephone: 765-287-1256

Website: <http://www.modelaircraft.org>

Association of Professional Model Makers

Toll-free telephone: 877-663-2766

Website: <http://www.modelmakers.org>

The Association of Professional Model Makers maintains a complete list of colleges and universities that offer modelmaking-related programs. Visit http://www.modelmakers.org/education_list.lasso.

International Plastic Modelers' Society USA

Website: <http://www.ipmsusa.org>

North American Model Engineering Society

Website:

<http://www.modelengineeringsoc.com>

Acknowledgments

The Boy Scouts of America is grateful to Jim Dore, AMS Phoenix Company, El Cajon, Calif., for his technical expertise and his role in revising the 2003 edition of *Model Design and Building*, upon which this 2009 edition is based.

We appreciate the Quicklist Consulting Committee of the Association for Library Service to Children, a division of the American Library Association, for its assistance with updating the resources section of this merit badge pamphlet.

Photo and Illustration Credits

Comstock—page 9 (*car; bottom right*)

HKS Inc., courtesy—pages 41 and 42

Jupiter.com—cover (*vise*); pages 2, 8 (*bottom*), 12 (*gloves*), 14 (*vise*), 16 (*cordless drill*), 19, 52 (*model airplane*), 53, and 58

Stockbyte—page 9 (*top*)

Thinkstock/Ryan McVay—page 27

Wikipedia.org/Tobias Grosch—page 24 (*bottom left*)

Wikipedia.org/Glenn McKechnie—page 16 (*scriber*)

Wikipedia.org/Arthur Spicer (layout creator)/Eric Guinther (photographer)—page 24 (*bottom right*)

Wikipedia.org/Marcus Wong—page 47 (*bottom*)

www.fingertip.fabrications.com/Steve Howarth, courtesy—page 60

All other photos and illustrations not mentioned above are the property of or are protected by the Boy Scouts of America.

Daniel Giles—page 12 (*right*)

John McDearmon—pages 20 (*both*), 21 (*top left*), 22 (*all*), 29–33 (*all*), 35–39 (*all*), 45–51 (*all illustrations*), and 54–55 (*all*)

MERIT BADGE LIBRARY

Though intended as an aid to Boy Scouts, Varsity Scouts, and qualified Venturers and Sea Scouts in meeting merit badge requirements, these pamphlets are of general interest and are made available by many schools and public libraries. The latest revision date of each pamphlet might not correspond with the copyright date shown below, because this list is corrected only once a year, in January. Any number of merit badge pamphlets may be revised throughout the year; others are simply reprinted until a revision becomes necessary.

If a Scout has already started working on a merit badge when a new edition for that pamphlet is introduced, *he may continue to use the same merit badge pamphlet to earn the badge and fulfill the requirements therein*. In other words, the Scout need not start over again with the new pamphlet and possibly revised requirements.

Merit Badge Pamphlet	Year	Merit Badge Pamphlet	Year	Merit Badge Pamphlet	Year
American Business	2002	Entrepreneurship	2006	Photography	2005
American Cultures	2005	Environmental Science	2006	Pioneering	2006
American Heritage	2005	Family Life	2005	Plant Science	2005
American Labor	2006	Farm Mechanics	2008	Plumbing	2004
Animal Science	2006	Fingerprinting	2003	Pottery	2008
Archaeology	2006	Fire Safety	2004	Public Health	2005
Archery	2004	First Aid	2007	Public Speaking	2002
Architecture and Landscape Architecture	2010	Fish and Wildlife Management	2004	Pulp and Paper	2006
Art	2006	Fishing	2009	Radio	2008
Astronomy	2010	Fly-Fishing	2009	Railroading	2003
Athletics	2006	Forestry	2005	Reading	2003
Automotive Maintenance	2008	Gardening	2002	Reptile and Amphibian Study	2005
Aviation	2006	Genealogy	2005	Rifle Shooting	2001
Backpacking	2007	Geocaching	2010	Rowing	2006
Basketry	2003	Geology	2005	Safety	2006
Bird Study	2005	Golf	2002	Salesmanship	2003
Bugling (see Music)		Graphic Arts	2006	Scholarship	2004
Camping	2005	Hiking	2007	Scouting Heritage	2010
Canoeing	2004	Home Repairs	2009	Scuba Diving	2009
Chemistry	2004	Horsemanship	2010	Sculpture	2007
Cinematography	2008	Indian Lore	2008	Shotgun Shooting	2005
Citizenship in the Community	2005	Insect Study	2008	Skating	2005
Citizenship in the Nation	2005	Inventing	2010	Small-Boat Sailing	2004
Citizenship in the World	2005	Journalism	2006	Snow Sports	2007
Climbing	2006	Landscape Architecture (see Architecture)		Soil and Water Conservation	2004
Coin Collecting	2008	Law	2003	Space Exploration	2004
Collections	2008	Leatherwork	2002	Sports	2006
Communication	2009	Lifesaving	2008	Stamp Collecting	2007
Composite Materials	2006	Mammal Study	2003	Surveying	2004
Computers	2009	Medicine	2009	Swimming	2008
Cooking	2007	Metalwork	2007	Textile	2003
Crime Prevention	2005	Model Design and Building	2010	Theater	2005
Cycling	2003	Motorboating	2008	Traffic Safety	2006
Dentistry	2006	Music and Bugling	2010	Truck Transportation	2005
Disabilities Awareness	2005	Nature	2003	Veterinary Medicine	2005
Dog Care	2003	Nuclear Science	2010	Water Sports	2007
Drafting	2008	Oceanography	2009	Weather	2006
Electricity	2004	Orienteering	2003	Whitewater	2005
Electronics	2004	Painting	2008	Wilderness Survival	2007
Emergency Preparedness	2008	Personal Fitness	2006	Wood Carving	2006
Energy	2005	Personal Management	2003	Woodwork	2003
Engineering	2008	Pets	2003		

BOY SCOUTS OF AMERICA • SUPPLY GROUP

NATIONAL DISTRIBUTION CENTER

2109 Westinghouse Boulevard
P.O. Box 7143
Charlotte, NC 28241-7143

www.scoutstuff.org

DIRECT MAIL CENTER

P.O. Box 909
Pineville, NC 28134-0909
For fast credit card orders—
VISA, MasterCard, American Express—
call BSA operators toll-free
1-800-323-0732